

Echotel® Model 355

Installation and Operating Manual



Cast aluminum housing with
Kynar® transducer



Lexan® housing with
polypropylene transducer

Two-Wire Non-Contact
Ultrasonic Transmitter
For Level, Volume,
and Open Channel Flow
Measurement

Read this Manual Before Installing

This manual provides information on the Echotel Model 355 Ultrasonic Transmitter. It is important that all instructions are read carefully and followed in sequence. Detailed instructions are included in the *Installation* section of this manual.

Conventions Used in this Manual

Certain conventions are used in this manual to convey specific types of information. General technical material, support data, and safety information are presented in narrative form. The following styles are used for notes, cautions, and warnings.

NOTES

Notes contain information that augments or clarifies an operating step. Notes do not normally contain actions. They follow the procedural steps to which they refer.

Cautions

Cautions alert the technician to special conditions that could injure personnel, damage equipment, or reduce a component's mechanical integrity. Cautions are also used to alert the technician to unsafe practices or the need for special protective equipment or specific materials. In this manual, a caution box indicates a potentially hazardous situation which, if not avoided, may result in minor or moderate injury.

WARNINGS

Warnings identify potentially dangerous situations or serious hazards. In this manual, a warning indicates an imminently hazardous situation which, if not avoided, could result in serious injury or death.

Safety Messages

Follow all standard industry procedures for servicing electrical and computer equipment when working with or around high voltage. Always shut off the power supply before touching any components. Although high voltage is not present in this system, it may be present in other systems.

Electrical components are sensitive to electrostatic discharge. To prevent equipment damage, observe safety procedures when working with electrostatic sensitive components.

Low Voltage Directive

For use in Installations Category I, Pollution Degree 2. If equipment is used in a manner not specified by the manufacturer, protection provided by equipment may be impaired.

 **WARNING** Explosion hazard. Do not connect or disconnect designs rated Explosion-proof or Non-incendive unless power has been switched off and/or the area is known to be non-hazardous

Notice of Copyright and Limitations

Magnetrol & Magnetrol logotype, STI & STI logotype and Echotel are registered trademarks of Magnetrol International.

Copyright © 2009 Magnetrol International, Incorporated
All rights reserved.

Performance specifications are effective with date of issue and are subject to change without notice. Magnetrol reserves the right to make changes to the product described in this manual at any time without notice. Magnetrol makes no warranty with respect to the accuracy of the information in this manual.

Warranty

All Magnetrol/STI electronic level and flow controls are warranted free of defects in materials or workmanship for one full year from the date of original factory shipment.

If returned within the warranty period; and, upon factory inspection of the control, the cause of the claim is determined to be covered under the warranty; then, Magnetrol/STI will repair or replace the control at no cost to the purchaser (or owner) other than transportation.

Magnetrol/STI shall not be liable for misapplication, labor claims, direct or consequential damage or expense arising from the installation or use of equipment. There are no other warranties expressed or implied, except special written warranties covering some Magnetrol/STI products.

Quality Assurance

The quality assurance system in place at Magnetrol/STI guarantees the highest level of quality throughout the company. Magnetrol is committed to providing full customer satisfaction both in quality products and quality service.

Magnetrol's quality assurance system is registered to ISO 9001 affirming its commitment to known international quality standards providing the strongest assurance of product/service quality available.



Echotel Model 355

Non-Contact Ultrasonic Transmitter

Table of Contents

1.0 Introduction	
1.1 Principle of Operation	4
2.0 Installation	
2.1 Unpacking	5
2.2 Electrostatic Discharge (ESD) Handling Procedure	5
2.3 Mounting and Application Considerations	6
2.3.1 Position	6
2.3.2 Orientation	6
2.3.3 Temperature	6
2.3.4 Obstructions	7
2.3.5 Pipe Nozzles	7
2.3.6 Foam	7
2.3.7 Vapors	7
2.3.8 Wind	7
2.3.9 Open Channel Flow Measurement	7
2.4 Wiring	8
2.4.1 General Purpose or Non-Incendive	8
2.4.2 Intrinsically Safe	9
2.4.3 Explosion Proof	9
2.5 Configuring the Transmitter	10
2.5.1 Basic Operating Parameters	10
2.5.2 Setting Up for Bench Configuration	10
2.5.3 Transmitter Initialization	10
2.5.4 Transmitter Display and Keypad	11
2.5.4.1 Menu Traversal Mode	11
2.5.4.2 Character Data Entry Mode	11
2.5.4.3 Numeric Digit Entry Mode	12
2.5.4.4 Increment/Decrement Entry Mode	12
2.5.5 Password Protection (Default = 0)	13
2.5.6 Configuration Menu Overview	13
2.5.7 Measured Values Menu	13
2.5.8 System Configuration Menu	16
2.5.8.1 Level Applications	17
2.5.8.2 Volume Applications	18
2.5.8.3 Open Channel Flow Applications	23
2.5.9 I/O Configuration Menu	30
2.5.10 Advanced Configuration Menu	34
2.5.11 Diagnostics Menu	41
2.5.12 Factory Configuration Menu	45
2.6 Configuration Using HART [®]	46
2.6.1 Connections	46
2.6.2 Display Menu	46
2.6.3 HART [®] Menu	47
3.0 Reference Information	
3.1 Troubleshooting	49
3.1.1 Troubleshooting System Problems	50
3.1.2 Error Messages	50
3.2 Measurement Range Calculations	52
3.3 Speed of Sound Through Gases	53
3.4 Parts	53
3.4.1 Replacement Parts	53
3.4.2 Replacement Spare Parts	54
3.5 Agency Approvals	54
3.5.1 Agency (FM/FMc) Drawing and Entity Parameters	55
3.6 Specifications	56
3.6.1 Transmitter	56
3.6.2 Transducer	56
3.6.3 Performance	56
3.6.4 Physical	57
3.7 Model Number	58
Model 355 Configuration Data Sheet	59

1.0 Introduction

Echotel Model 355 is a two-wire non-contact transmitter that performs level, volume, and open channel flow measurements in a wide variety of industrial and municipal applications. A maximum range of 20 feet (6 meters) can be measured under ideal conditions. The maximum range will be less than this if there is excessive turbulence, foam or other adverse application conditions. The user should consult section 3.2, Measurement Range Calculations, to make sure that the Model 355 is suited for the specific application.

1.1 Principle of Operation

Non-contact ultrasonic measurement is obtained by emitting an ultrasonic pulse from the transducer and measuring the time required for the echo to reflect from the liquid surface and return to the transducer. The Model 355 measures the time of the round trip pulse and calculates the distance using the equation:

$$D = \frac{V_a T}{2}$$

D = Distance to target

V_a = Velocity of sound through air (1,128 ft/sec.)

T = Time for one round trip sound pulse

Since the speed of sound is temperature dependent, the transducer also measures the temperature at the transducer to provide compensation for changing air temperatures. Level is computed by the 355 electronics using the measured distance and the configuration data that has been entered for the vessel dimensions.

By knowing the vessel type and its dimensions, the electronics can calculate the liquid volume in the vessel. In a similar operation, the Model 355 can perform open channel flow measurement by converting the level reading into units of volume per unit of time. Common tank shapes, flumes and weirs are stored in the 355 software. A 20-point linearization table is also available for unusual tanks or primary flow elements.

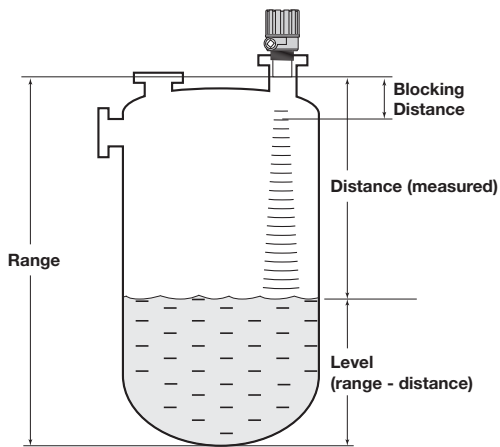

Level/Volume Application

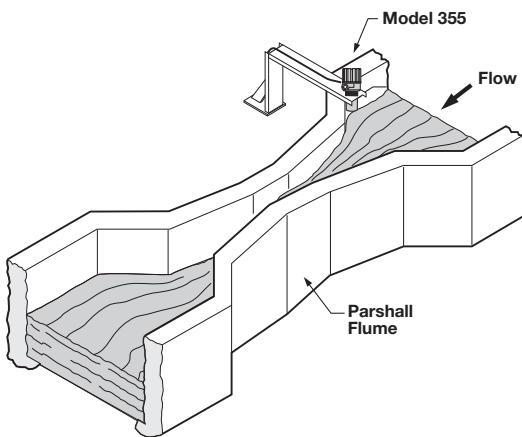

Open Channel Flow Application

2.0 Installation

This section provides detailed procedures for properly installing, configuring, and, as needed, troubleshooting the Model 355 Ultrasonic Transmitter.

2.1 Unpacking

Unpack the instrument carefully. Make sure all components have been removed from the packing material. Check all the contents against the packing slip and report any discrepancies to the factory.

Before proceeding with the installation, do the following:

- Inspect all components for damage. Report any damage to the carrier within 24 hours.
- Make sure the model number on the nameplate agrees with the packing slip and purchase order.
- Record the model and serial numbers for future reference when ordering parts.

Model Number

Serial Number

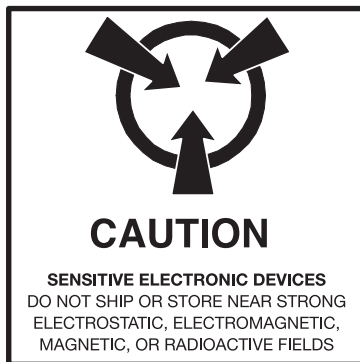

2.2 Electrostatic Discharge (ESD) Handling Procedure

Magnetrol's electronic instruments are manufactured to the highest quality standards. These instruments use electronic components that may be damaged by static electricity present in most work environments.

The following steps are recommended to reduce the risk of component failure due to electrostatic discharge.

- Ship and store circuit boards in anti-static bags. If an anti-static bag is not available, wrap the board in aluminum foil. Do not place boards on foam packing materials.
- Use a grounding wrist strap when installing and removing circuit boards. A grounded workstation is recommended.
- Handle circuit boards only by the edges. Do not touch components or connector pins.
- Make sure that all electrical connections are completely made and none are partial or floating. Ground all equipment to a good earth ground.

2.3 Mounting and Application Considerations

Caution: Unit should only be hand-tightened into the process connection. Overtightening may cause transducer errors and will void the warranty.

Caution: The Model 355 uses a thermoplastic transducer that should not be used in liquid media that have esters or ketones.

Special Conditions for Safe Use:

1. Materials marked as Category I equipment and used in hazardous areas requiring this category shall be installed in such a way that, even in the event of rare incidents, the aluminum enclosure cannot be an ignition source due to impact or friction
2. The transmitter shall be installed so that electrostatic discharges on plastic parts are prevented.

NOTE: Remove the black protective plastic cap from the end of the transducer.

There are several application considerations that should be evaluated prior to installing a non-contact ultrasonic transmitter. The next few pages should be read thoroughly to ensure that the Model 355 will perform as expected in the given application. Section 3.2, Measurement Range Calculations, provides derating multipliers that should be used to determine the maximum potential range in difficult applications.

2.3.1 Position

The optimum mounting position of the Model 355 is between $\frac{1}{2}$ and $\frac{2}{3}$ of the radius of the (cylindrical) tank. This will position the unit to minimize any interference that the 10° beam (5° half angle) has with the tank walls or any agitator blades that exist in the tank. Refer to the Beam Radius vs. Distance figure at left.

2.3.2 Orientation

The face of the transducer must be parallel to the liquid surface within 2° to 3° for proper operation.

2.3.3 Temperature

Ensure that the Model 355 will be protected against overheating by intense direct sunshine. When the unit will be subjected to severe direct sun, the use of a sunshade is recommended.

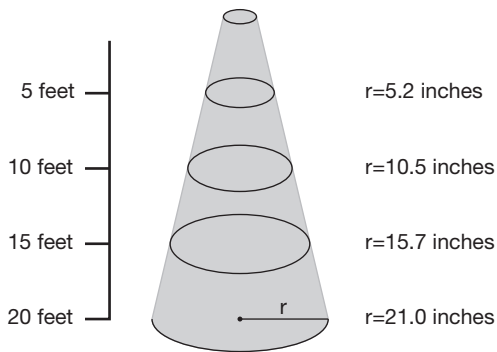

Beam Radius (r) vs. Distance

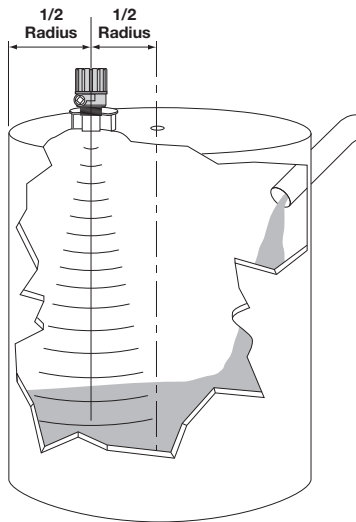

Mounting Position

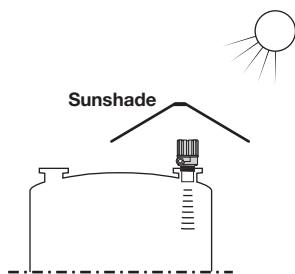

Sunshade Recommendation

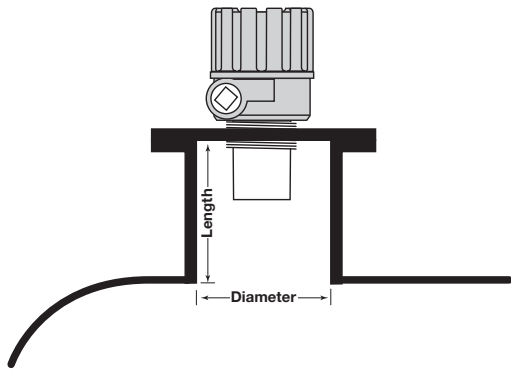

Standpipe Diameter	Maximum Length
2" (50 mm)	Not Recommended
3" (75 mm)	9" (225 mm)
4" (100 mm)	12" (300 mm)
5" (125 mm)	15" (375 mm)
6" (150 mm)	18" (450 mm)
8" (200 mm)	20" (500 mm)

Standpipe Mounting

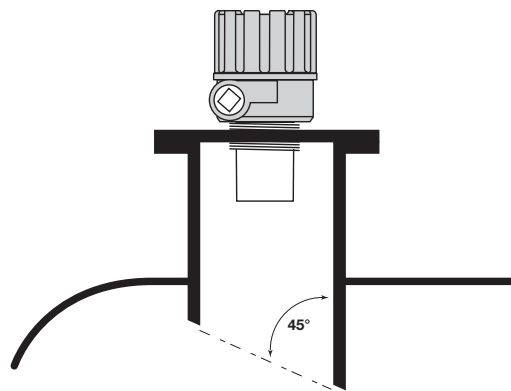

Nozzle Cut

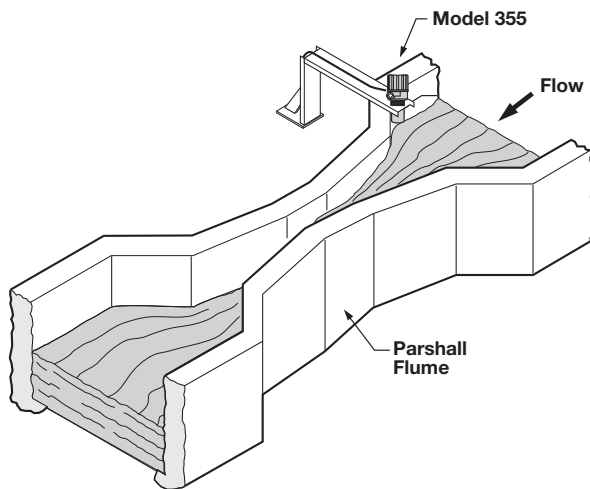

Open Channel Flow Mounting

2.3.4 Obstructions

Preferred mounting is such that no obstacles (e.g., fill pipes, ladders, bracing members, agitator blades, etc.) obstruct the ultrasonic beam. Minor obstacles in the path of the ultrasonic beam can be programmed out through the use of the Echo Profile menu in Advanced Configuration. For further information on vessel obstructions, see Section 3.2, Measurement Range Calculations.

2.3.5 Pipe Nozzles

Ideally, the 355 should be mounted so that the transducer face is at least 10" (250 mm) above the highest anticipated level. In applications where the material level may come into the blocking distance, the transducer can be mounted in a pipe nozzle (standpipe). The inner rim of the nozzle must be smooth and free of burrs. False echoes can sometimes be produced by the change in impedance at the end of a nozzle. Cutting the bottom of the nozzle at a 45° angle is suggested to help eliminate false echoes by reducing this impedance change. The maximum length for a given diameter of nozzle is shown at left.

2.3.6 Foam

Foaming of the liquid surface may render ultrasonic level measurement impossible. If possible, a mounting location should be found where foaming is at a minimum. Another alternative is to install the transducer in a stilling well that extends below the lowest level to be measured in the tank. Refer to Section 3.2, Measurement Range Calculations, for more information.

2.3.7 Vapors

Closed tanks that contain chemicals or other liquids that create vapors may severely reduce the maximum measuring range. Refer to the Section 3.2, Measurement Range Calculations for more information.

2.3.8 Wind

Strong air flow or wind in the vicinity of the ultrasonic beam should be avoided. A strong wind may prevent the return echo from being received by the transducer.

2.3.9 Open Channel Flow Measurement

For the best accuracy, mount the transducer as close as possible above the expected maximum water level (Head) in the flume or weir (usually 12 to 18 inches (300 to 450 mm) higher than the maximum head in the flume or weir).

Install the Model 355 on the inflow side of the flume throat or weir crest in the location defined by the manufacturer of the primary measuring device. The unit should also be aligned with the longitudinal axis of the flume or weir.

2.4 Wiring

Caution: The Echotel Model 355 transmitter operates at voltages of 16 to 36 VDC (GP), 16 to 28.6 VDC (IS) and 16 to 36 VDC (XP). Higher voltage will damage the transmitter.

Caution: The Lexan® housing should only be used as “end of line”, with one conduit entry plugged. If cable glands are used with the Lexan housing, they should be non-metallic.

Wiring between the power supply and the Echotel Model 355 transmitter should be made using 18–22 AWG shielded twisted pair instrument cable. Wiring must be suitable for temperatures up to at least +185° F (+85° C). Within the transmitter enclosure, connections are made to the terminal strip and the ground connections. The directions for wiring the Echotel Model 355 transmitter depend on the application:

- General Purpose or Non-incendive (CI I, Div. 2)
- Intrinsically Safe
- Explosion Proof

2.4.1 General Purpose or Non-Incendive

This equipment is suitable for installation in Class I, Division 2, Groups A, B, C, and D hazardous or non-hazardous locations.

⚠ WARNING Explosion Hazard. Substitution of components may impair suitability for Class I, Division 2.

A general purpose installation does not have flammable media present. Areas rated non-incendive (CI I, Div. 2) have flammable media present only under abnormal conditions. No special electrical connections are required.

Caution: If flammable media is contained in the vessel, the transmitter must be installed per CI I, Div. 1 standards of area classification.

To install General Purpose or Non-Incendive wiring:

1. Remove the cover of the transmitter. Install the conduit plug in the unused opening. Use PTFE tape/sealant to ensure a liquid-tight connection.
2. Install a conduit fitting and pull the supply wires.
3. Connect shield to an earth ground at power supply.
4. Connect an earth ground wire to the green ground screw. Use a minimum 18 AWG wire rated up to +185° F (+85° C).
5. Connect the positive supply wire to the (+) terminal and the negative supply wire to the (-) terminal.
6. Replace the cover of the transmitter.

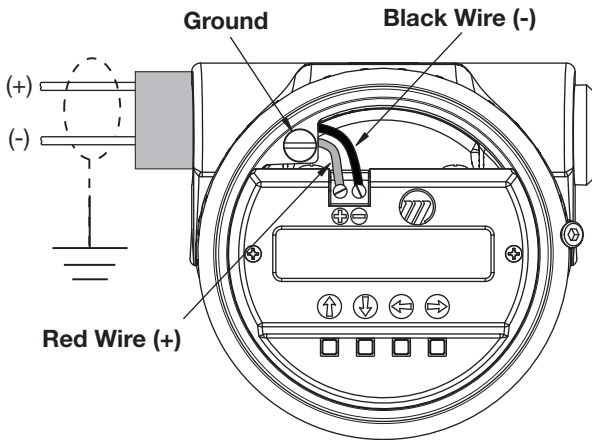

Wiring Diagram

2.4.2 Intrinsically Safe

An intrinsically safe (IS) installation potentially has flammable media present. An approved IS barrier must be installed in the non-hazardous (safe) area. See Agency Drawing, Section 3.5.1.

To install Intrinsically Safe wiring:

1. Make sure the IS barrier is properly installed in the safe area (refer to local plant or facility procedures). Complete the wiring from the barrier to the Echotel 355 transmitter.
2. Remove the cover of the transmitter. Install the conduit plug in the unused opening. Use PTFE tape/sealant to ensure a liquid-tight connection.
3. Install a conduit fitting and pull the supply wires.
4. Connect shield to an earth ground at power supply.
5. Connect an earth ground wire to the green ground screw. Use a minimum 18 AWG wire rated up to +185° F (+85° C).
6. Connect the positive supply wire to the (+) terminal and the negative supply wire to the (-) terminal.
7. Replace the cover of the transmitter.

2.4.3 Explosion Proof



WARNING Explosion hazard. Do not disconnect equipment unless power has been switched off or the area is known to be non-hazardous.

Explosion Proof (XP) is a method of designing equipment for installation in hazardous areas. A hazardous location is an area in which flammable gases or vapors are, or may be, present in the air in quantities sufficient to produce explosive or ignitable mixtures. The wiring for the transmitter must be contained in Explosion Proof conduit extending into the safe area. See Agency Approvals, Section 3.5.

To install Explosion Proof wiring:

1. Install Explosion Proof conduit from the safe area to the conduit connection of the Echotel Model 355 transmitter (refer to local plant or facility procedures).
2. Remove the cover of the transmitter.
3. Connect shield to an earth ground at the power supply.
4. Connect an Earth ground wire to the green ground screw per local electrical code. Use a minimum 18 AWG wire rated up to +185° F (+85° C).
5. Connect the positive supply wire to the (+) terminal and the negative supply wire to the (-) terminal.
6. The cover must be completely installed before power may be applied.

2.5 Configuring the Transmitter

Echotel Model 355 Ultrasonic Transmitters do not need to be calibrated since they operate purely as time-of-flight units based on the speed-of-sound. Configuring the Model 355 for a specific level, volume, or open channel flow application can be completed in minutes. Configuration is easily performed at the vessel, or on a bench prior to being installed in the field.

2.5.1 Basic Operating Parameters

The following operating parameters are used in configuring the Model 355 ultrasonic transmitter:

- **Range:** Distance from the face of the transducer to the bottom of the vessel/channel.
- **Blocking Distance:** Minimum distance of 10" (250 mm) in front of the transducer that is a "blind space" where the transmitter cannot make any measurements.
- **Level Offset:** If any obstructions (heating coils, mixing blades, angled bottoms, etc.) exist at the bottom of the tank, a Level Offset can be set to ignore reflections from these objects.
- **Distance:** This is measured by the transmitter independent of any of the configuration data. It is distance from the face of the transducer to the target.
- **Level:** Computed by the transmitter as the configured Range minus the measured Distance.

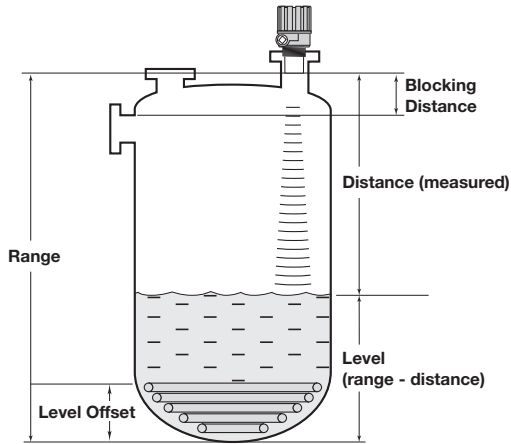

Configuration Parameters

2.5.2 Setting Up for Bench Configuration

The Model 355 can be configured at a test bench by connecting a 24 VDC power supply directly to the transmitter terminals. Section 2.4 shows the wiring connections. When using a HART communicator for configuration, a minimum 250 Ω line load resistance is required. See the HART communicator manual for more information.

To verify basic operation the 355 can be pointed at a stable target at an appropriate distance and held steady. This can be accomplished by holding the unit 2 to 4 feet (610 to 1220 mm) from the floor and observing the display for 1–2 minutes.

2.5.3 Transmitter Initialization

When power is first applied to the unit, the transmitter goes through an initialization period. During this period the unit will show "Initializing." After approximately 30 seconds the Model 355 will either begin to display measured values such as "Level" and "Distance," or display another status screen if a diagnostic condition is present.

2.5.4 Transmitter Display and Keypad





The 355 transmitter has a local user interface consisting of a 2-line by 16-character liquid crystal display (LCD) and 4-push-button keypad. All transmitter measurement data and configuration information is shown in the LCD.

While configuring the unit with the local user interface the transmitter cover is off and all 16 characters can be displayed by the LCD. During normal operation the cover obscures part of the LCD and only 12 characters are shown. For this reason, the Measured Values and Diagnostic data are shown as 12 characters per line so that they can be completely seen through the cover window.

Model 355 is configured via a “tree” type menu structure, where it is easy to access branches of the tree to configure the various transmitter parameters. The four push buttons have different functions for various operating modes within the menu structure.





2.5.4.1 Menu Traversal Mode

When going from one branch of the menu to another the push buttons operate as follows:

Push button		Keystroke Action
	Up	Moves to the previous item in the menu branch
	Down	Moves to the next item in the menu branch
	Back	Moves back one level to the previous higher branch item
	Enter	Enters into the lower level branch or switches to the entry mode





2.5.4.2 Character Data Entry Mode

This mode is most commonly used when entering a new local tag into the 355 transmitter. The local tag as shipped from the factory is “Model 355” but can be changed to have the actual tag number of the vessel or primary element. When entering data in the Character Data Entry Mode, the leftmost character on the lower line of the LCD will be a cursor. Data is entered at the cursor by using the push buttons as follows:

Push button		Keystroke Action
	Up	Moves to the previous character (Z,Y,X,W). If held down the characters scroll until the push button is released.
	Down	Moves to the next item character (A,B,C,D). If held down the characters scroll until the push button is released.
	Back	Moves the cursor back to the left. If the cursor is already at the leftmost position, then the screen is exited without changing the original tag characters.
	Enter	Moves the cursor forward to the right. If the cursor is at the rightmost position, then the new tag is saved.

2.5.4.3 Numeric Digit Entry Mode



The Numeric Digit Entry Mode is used to enter most of the numeric values in the System and I/O Configuration screens. This mode is accessed when the Enter  key is pressed on a menu item that presents a saved numeric value such as the Range setting. Data is entered at the cursor by using the push buttons as follows:





Push button		Keystroke Action
	Up	Moves up to the next highest digit (0,1,2,3,...,9). If held down the digits scroll until the push button is released.
	Down	Moves down to the next lowest digit (9,8,7,6,...,0). If held down the digits scroll until the push button is released.
	Back	Moves the cursor to the left and deletes a digit. If the cursor is already at the leftmost position, then the screen is exited without changing the previously saved value.
	Enter	Moves the cursor to the right. If the cursor is located at a blank character position, the new value is saved.

NOTE: All numeric values are left-justified, and new values are entered from left to right. A decimal point can be entered after the first digit is entered, such that .9 is entered as 0.9.

NOTE: A few configuration items can have a negative value. In this case, the leftmost position is reserved for the sign (either “-“ for a negative value, or “+” for a positive value)

2.5.4.4 Increment/Decrement Digit Entry Mode

The Increment/Decrement Digit Entry Mode is used to trim or revise some numeric values. An example is the Trim Level screen in System Configuration which has a default value of 0.0. When the Enter  key is pushed in the Trim Level screen, a double headed arrow () is shown as the rightmost character of the LCD lower line. When the () is present, the value can be revised by using the push buttons as follows:

Push button		Keystroke Action
	Up	Increments the displayed value. If held down the digits scroll until the push button is released. Depending on which screen is being revised, the increment amount may increase by a factor of 10 after the value has been incremented 10 times.
	Down	Decrements the displayed value. If held down the digits scroll until the push button is released. Depending on which screen is being revised, the decrement amount may increase by a factor of 10 after the value has been decremented 10 times.
	Back	Returns to the previous menu without changing the original value, which is immediately redisplayed.
	Enter	Accepts the displayed value and returns to the previous menu.

2.5.5 Password Protection (Default = 0)

The 355 transmitter can be password protected to restrict access to certain portions of the menu structure that affect the operation of the system. The default user password installed in the 355 transmitter at the factory is 0, which effectively disables the user password feature. This allows a complete configuration to be done without entering a password.

If desired, a new user password can be entered in Advanced Configuration in the New Password screen. The password can be changed to any numerical value up to 255. If the password is changed from the factory default value of 0, then the new password will be required whenever any configuration values are changed.

NOTE: If the password is not known, the menu item New Password in Advanced Configuration displays an encrypted value representing the present password. Contact the factory with this encrypted value to determine the actual password.





2.5.6 Configuration Menu Overview

Configuration of the Model 355 is performed by use of a tree-like menu structure. The figure on the next page shows an overview of the top level menu items.

2.5.7 Measured Values Menu

The Measured Values Menu (see page 15) contains all the possible measured or calculated values that the 355 transmitter can display for level, volume, and open channel flow applications. For simple level applications there are many screens (such as Volume, Flow, Head, and the totalizers) that are not applicable and will show values of zero.

The Measured Values Menu is also used to add or remove parameters from the Home Menu. The Home Menu appears on the LCD after the 355 is powered up and has gone through the 30 second initialization period. Home Menu parameters are shown as 12-characters or less, and have asterisks on either side of the top line of the LCD. The Home Menu parameters rotate at a 2-second interval on the LCD.

From the factory, the Home Menu will show the Level value. To add or remove parameters from the Home Menu, push the Enter  key. Use the Up  or Down  keys to remove them (Off Main Disp) or add them (On Main Disp) from the rotating Home Menu display. To exit the Measured Values screen push the Back  key.

Any of the Measured Values screens can be left on the LCD without returning to the rotating Home Menu. To return to the rotating Home Menu, simply push the Back  key twice.

(2.5.6) Configuration Menu Overview

This Configuration Menu Overview shows the top level of the Model 355 firmware. See the referenced pages for further information on each branch of the tree-like menu structure.

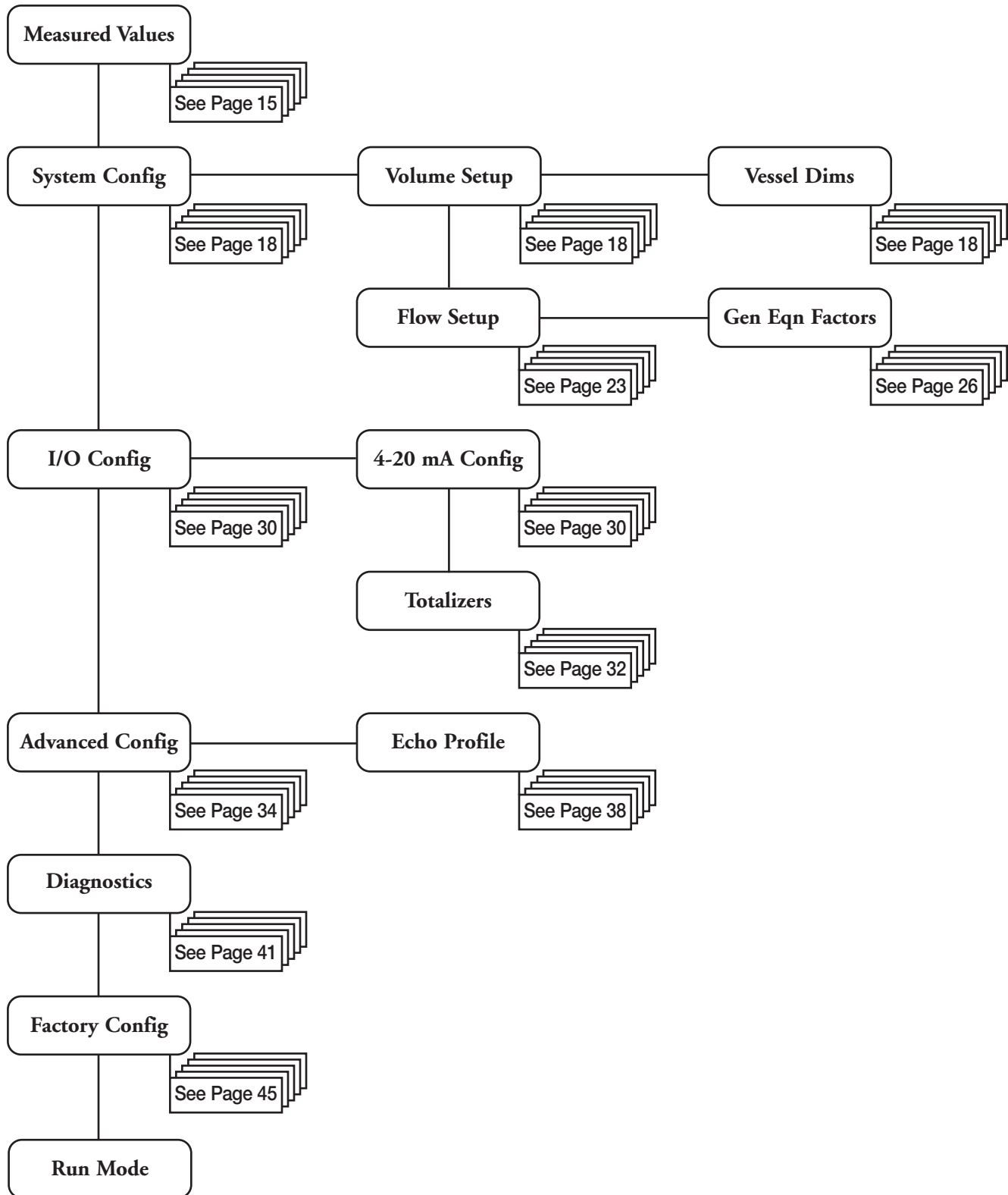

(2.5.7) Measured Values Menu

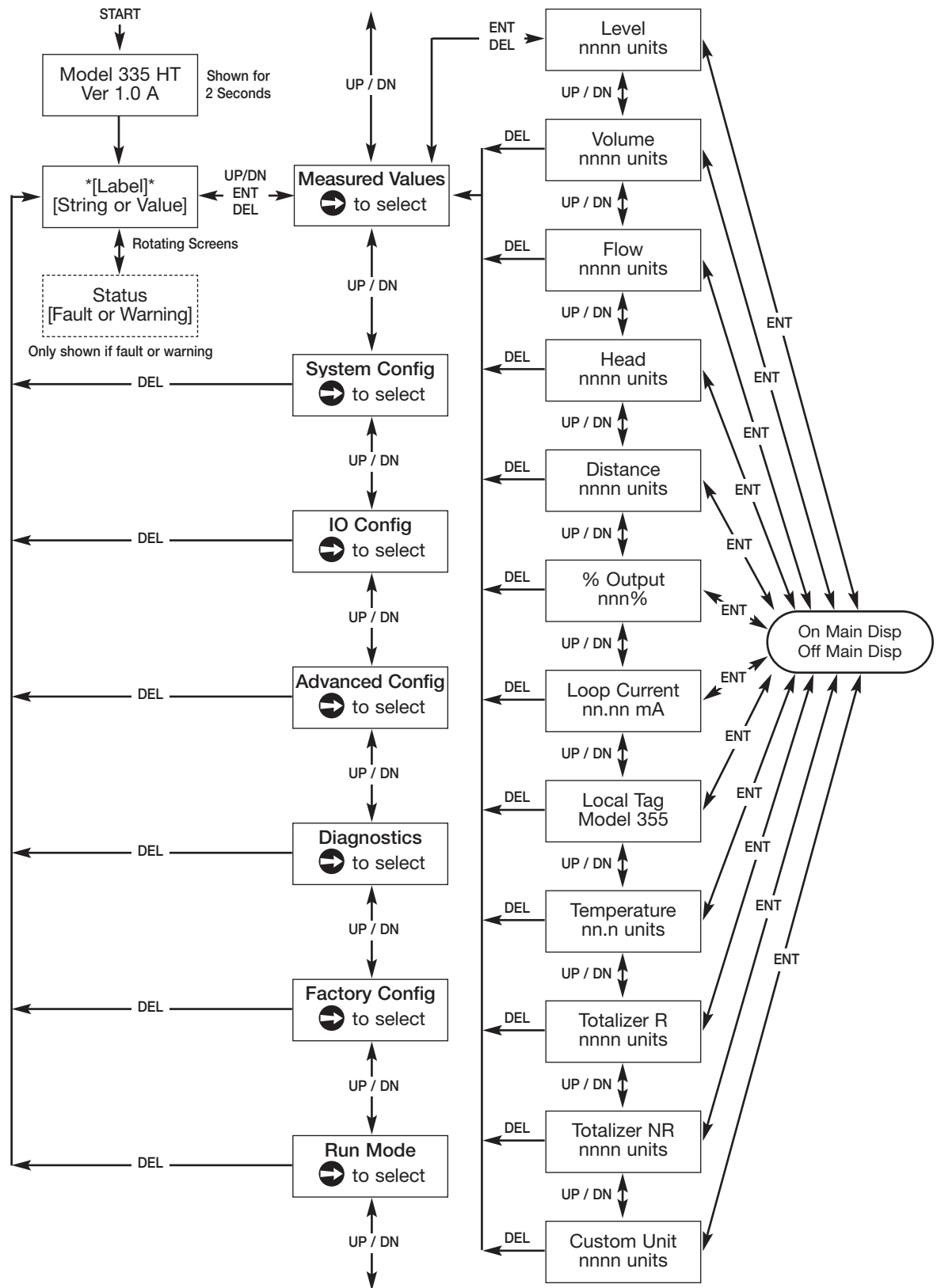

2.5.8 System Configuration Menu

The System Configuration Menu shown below contains all the parameters that are needed to configure the 355 for level applications. This menu is also used for Volume & Level and Flow & Level configurations:

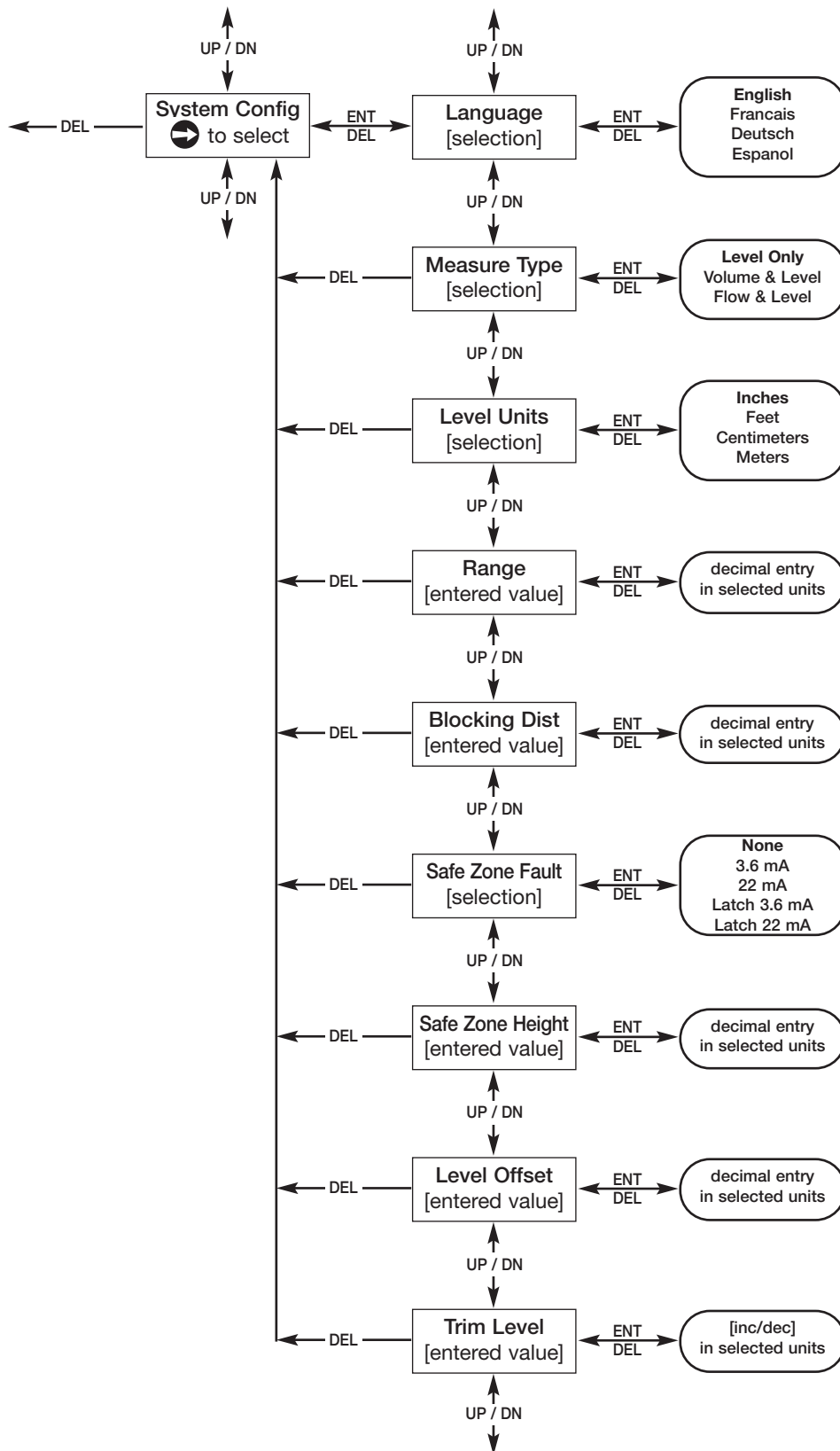

2.5.8.1 System Configuration Menu – Level Applications

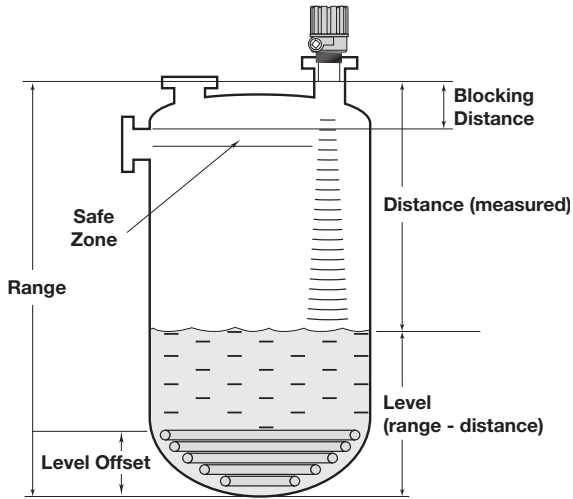

The System Configuration Menu on the opposite page contains all the parameters that are needed to configure the 355 for level applications. Additional System Configuration parameters are used for volume (page 18) or open channel flow applications (page 23). The following table provides an explanation of each of the System Configuration parameters for level applications.

Configuration Parameter	Explanation (Level Applications)
Language	The 355 can be configured in English (default value), French , German or Spanish .
Measure Type	The 355 can be configured as a Level Only (default value), Volume & Level , or Open Channel Flow & Level transmitter.
Level Units	A selection of Inches (default value), Feet , Centimeters , or Meters is provided. Should some other units of level be desired, the <i>Custom Unit</i> feature can be used in the Advanced Configuration Menu.
Range	<i>Range</i> is defined as the distance from the face of the transducer to the bottom of the tank for level applications. This distance needs to be measured accurately for proper level indication. Factory default value is 240.0 inches.
Blocking Dist	The <i>Blocking Distance</i> is a “blind space” or “dead zone” immediately in front of the transducer where level measurement cannot be made. The 355 defaults to a minimum <i>Blocking Distance</i> of 10" (250 mm). If needed, a larger value can be entered to help ignore potential false echoes originating from the bottom rim of a nozzle, or other objects close to the transducer.
Safe Zone Fault	Ultrasonic transmitters cannot reliably measure level if the liquid enters the <i>Blocking Distance</i> . For this reason, a <i>Safe Zone</i> (see drawing above) can be configured in a user-defined area just below the <i>Blocking Distance</i> . If desired, a <i>Safe Zone Fault</i> can be set to ensure safe, reliable high-level readings in critical applications. Choices are None (default value), 3.6 mA , 22 mA , Latch 3.6 mA , or Latch 22 mA . If Latch 3.6 mA or Latch 22 mA is chosen, the loop current will remain in alarm until it is manually cleared with the <i>Safe Zone Alarm Reset</i> located in the Diagnostics Menu.
Safe Zone Height	<i>Safe Zone Height</i> is entered as the distance just below the <i>Blocking Distance</i> that establishes a <i>Safe Zone</i> . If the liquid level enters this zone the 355 will report the chosen <i>Safe Zone Fault</i> . Factory default value is 2.0 inches.
Level Offset	A <i>Level Offset</i> (see drawing above) can be established at the bottom of the tank if any obstructions (heating coils, mixing blades, angled bottoms, etc.) exist that have the potential to create false level reflections. It is the distance from the bottom of the tank to the lowest valid level reading. The 355 will not display any levels (on the LCD or the mA loop) lower than the <i>Level Offset</i> value. Factory default value is 0.0".
Trim Level	<i>Trim Level</i> is an offset value (maximum of $\pm 10"$ or 25.4 cm) that can be used to force the output the exact level. This should only be used after all parameters have been entered correctly, and it has been confirmed that the transmitter is tracking the correct level target.

2.5.8.2 System Configuration Menu – Volume Applications

The level System Configuration parameters on pages 16 & 17 need to be entered before the volume configuration can be done. Enter these parameters prior to starting the volume configuration shown below.

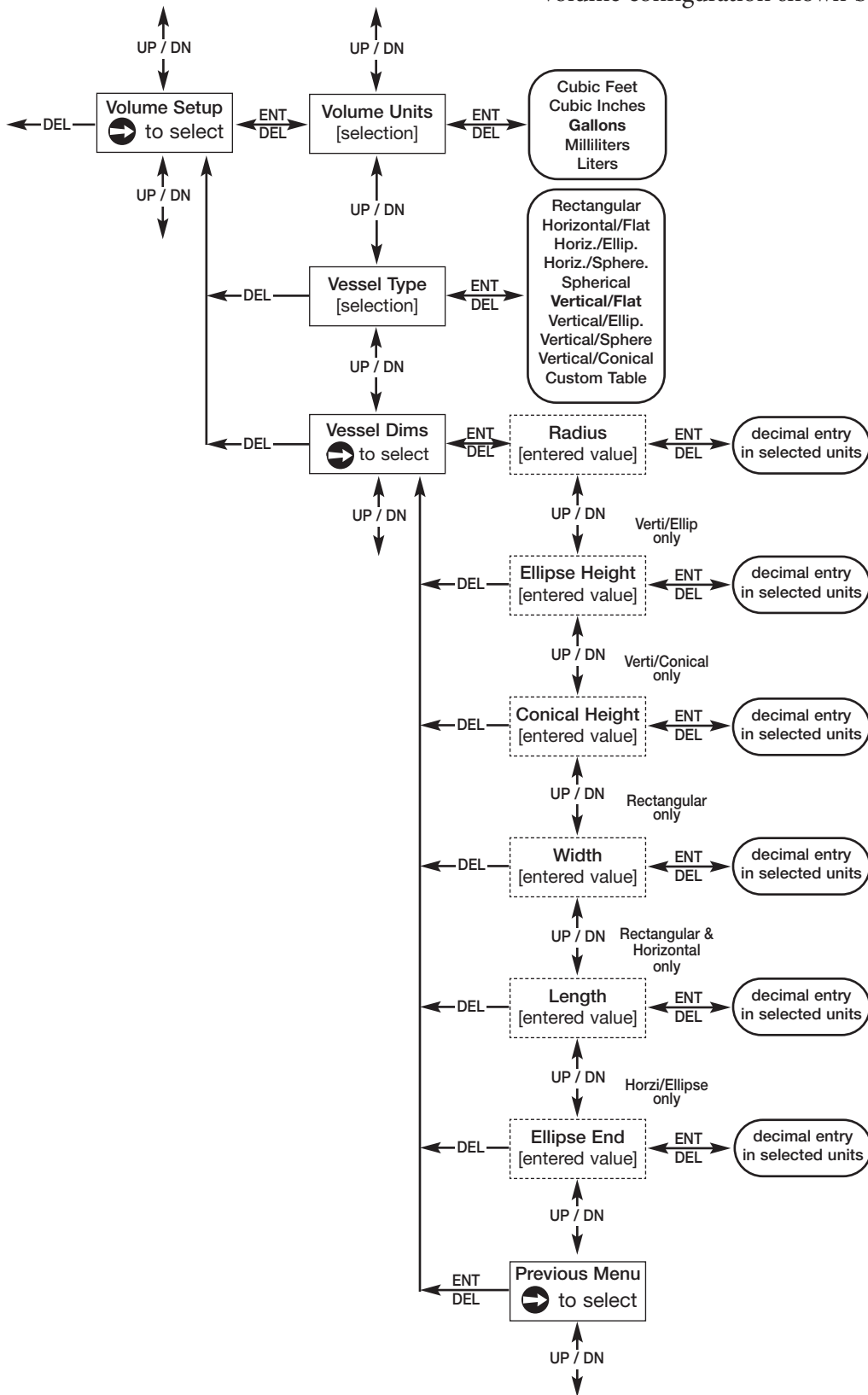

2.5.8.2 System Configuration Menu – Volume Applications (cont.)

The following table provides an explanation of each of the System Configuration parameters for volume applications that use one of the nine Vessel Types. See below and page 20 for dimensional information on all nine Vessel Types.

Configuration Parameter	Explanation (Volume Applications)
Volume Units	A selection of Gallons (factory default <i>Volume Unit</i>), Milliliters , Liters , Cubic Feet , or Cubic Inches , is provided. Should some other units of volume be desired, the <i>Custom Unit</i> feature can be used in the Advanced Configuration Menu.
Vessel Type	Select either Vertical/Flat (factory default <i>Vessel Type</i>), Vertical/ Ellip. , Vertical/Sphere , Vertical/Conical , Custom Table , Rectangular , Horizontal/Flat , Horiz./Ellip. , Horiz./Sphere , or Spherical .
Note: Vessel Dims is the next screen only if a specific Vessel Type was selected. If Custom Table was selected, turn to page 21 & 22 to select the <i>Cust Table Type</i> and <i>Cust Table Vals</i> .	
Vessel Dims	Depending on which <i>Vessel Type</i> was selected, the next few screens will allow entry of the vessel dimensions. See the vessel drawings below and on page 20 for proper dimensions.
	Radius is used for all <i>Vessel Types</i> with the exception of <i>Rectangular</i> vessels.
	Ellipse Height is only used for <i>Vertical/Ellip</i> vessels.
	Conical Height is only used for <i>Vertical/Conical</i> vessels.
	Width is only used for <i>Rectangular</i> vessels.
	Length is only used for <i>Rectangular</i> and the three <i>Horizontal</i> vessels.
	Ellipse End is only used for <i>Horiz/Ellip</i> vessels.
	Previous Menu exits the <i>Vessel Dims</i> menu.

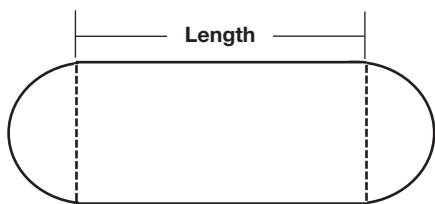

HORIZONTAL/SPHERICAL

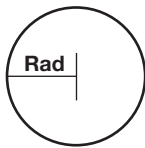

Side View

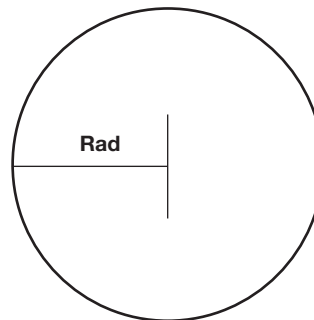

SPHERICAL

Vessel Types

Vessel Types

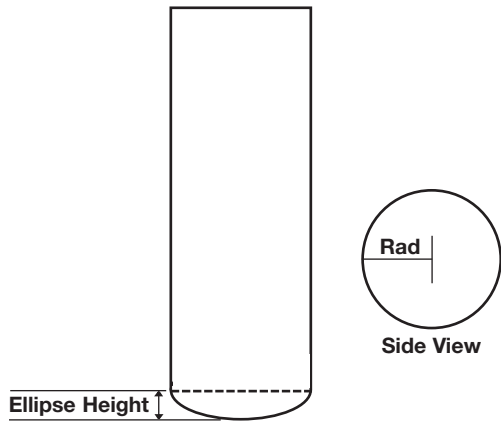

VERTICAL/ELLIPTICAL

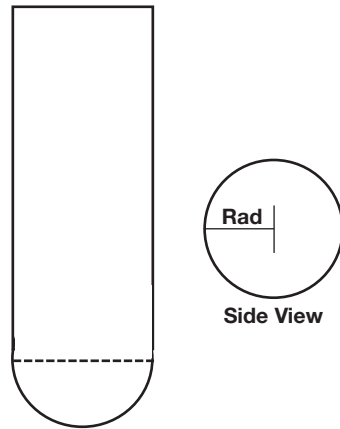

VERTICAL/SPHERICAL

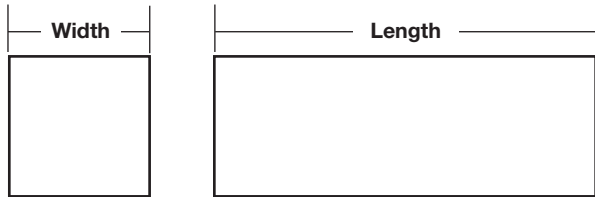

RECTANGULAR

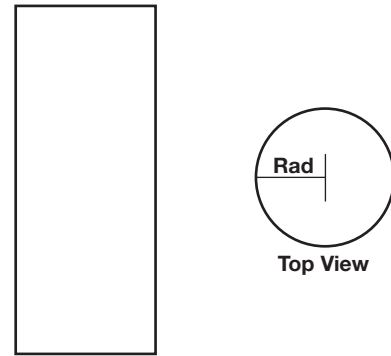

Top View

VERTICAL/FLAT

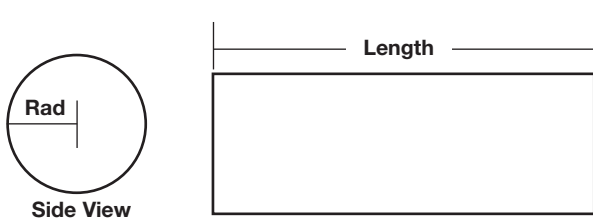

Side View

HORIZONTAL/FLAT

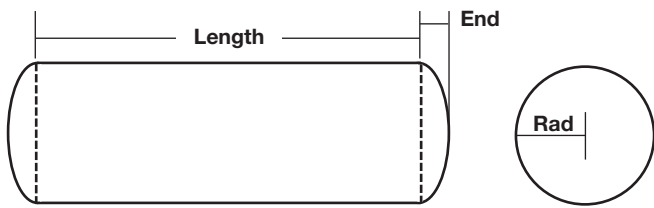

Side View

HORIZONTAL/ELLIPTICAL

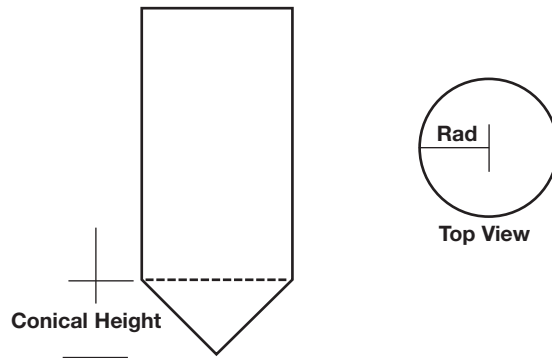

Top View

VERTICAL/CONICAL

2.5.8.2 System Configuration Menu – Volume Applications (cont.)

If none of the nine *Vessel Types* from pages 19 & 20 can be used, a *Custom Table* can be created. A maximum of 20 points can be used to establish the level to volume relationship. The following table provides an explanation of each of the System Configuration parameters for volume applications where a *Custom Table* is needed.

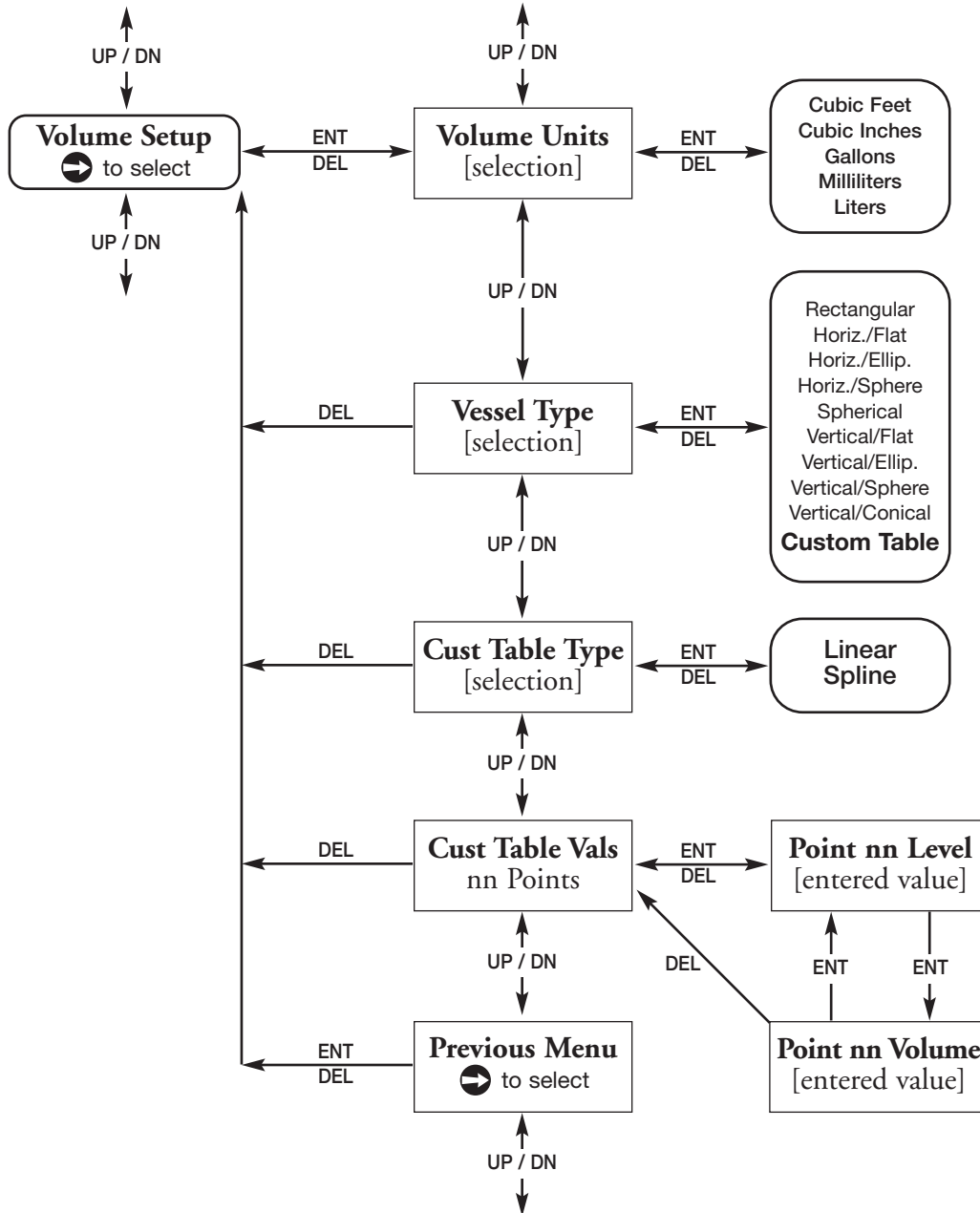

2.5.8.2 System Configuration Menu – Volume Applications (cont.)

The level System Configuration parameters on pages 16 & 17 need to be entered before the volume configuration can be done. Enter these parameters prior to starting the volume configuration shown below.

Configuration Parameter	Explanation (Custom Table Volume Applications)
Volume Units	A selection of Gallons (factory default <i>Volume Unit</i>), Milliliters , Liters , Cubic Feet , or Cubic Inches , is provided. Should some other units of volume be desired, the <i>Custom Unit</i> feature can be used in the Advanced Configuration Menu.
Vessel Type	Select Custom Table if none of the nine <i>Vessel Types</i> can be used.
Note: <i>Custom Table Type</i> is the next screen only if a <i>Custom Table</i> was selected. If one of the nine <i>Vessel Types</i> can be used, refer to page 19 to select the <i>Vessel Type</i> and <i>Vessel Dims</i> .	
Cust Table Type	The <i>Custom Table</i> points can be a Linear (straight line between adjacent points) or Spline (can be a curved line between points) relationship. See below drawing for more information.
Cust Table Vals	A maximum of 20 points can be used in building the <i>Custom Table</i> . Each pair of values will have a level (height) in the units chosen in the <i>Level Units</i> screen, and the associated volume for that level point. The values must be monotonic, i.e. each pair of values must be greater than the previous level/volume pair. The last pair of values should have the highest level value (usually the <i>Range</i> value) and the volume associated with that level in the vessel.
Previous Menu	Previous Menu exits the <i>Custom Table</i> menu.

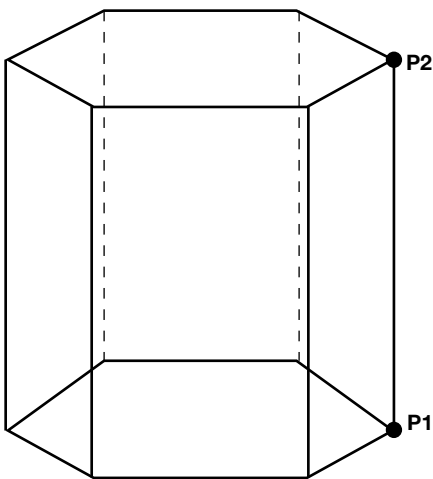

LINEAR

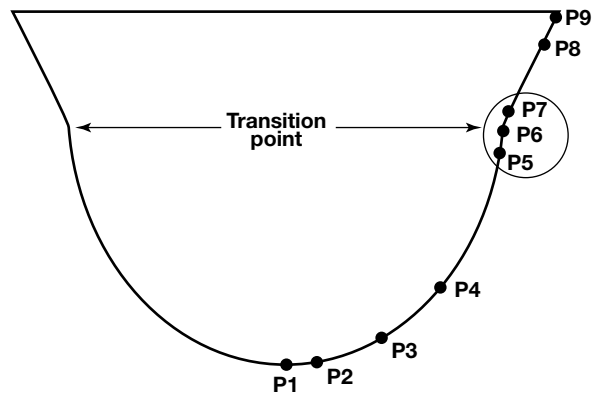

Use where walls are not perpendicular to base.

Concentrate at least two points at beginning (P1) and end (P9); and three points at either side of transition points.

SPLINE

2.5.8.3 System Configuration Menu – Open Channel Flow Applications

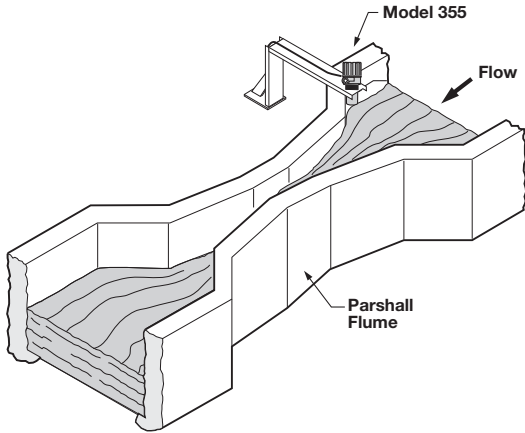

**Open Channel Flow Measurement
Parshall Flume**

Open channel flow is performed by using the 355 to measure the level (Head) in a hydraulic structure. The hydraulic structure is the primary measuring element, of which the two most common types are weirs and flumes. Since the primary element has a defined shape and dimensions, the rate of flow through the flume or over the weir is related to the liquid level (Head) at a specified measurement location.

The Model 355 is the secondary measuring device, which measures the height (Head) of the liquid in the flume or weir. Open channel flow equations stored in the 355 firmware convert the measured Head into units of flow (volume/time).

NOTE: Proper position of the Model 355 should be per the recommendation of the flume or weir manufacturer.

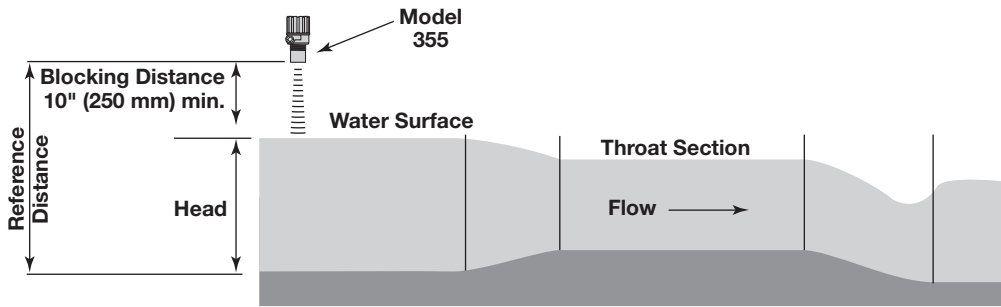

Flume (side view)

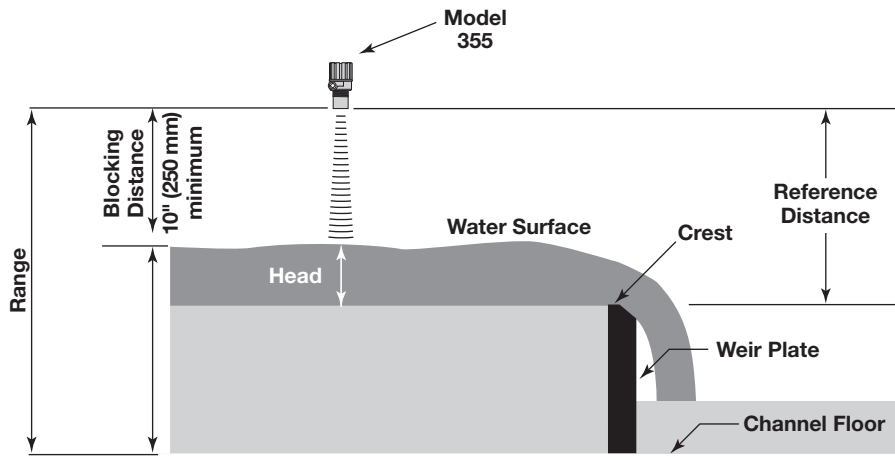

Weir (side view)

2.5.8.3 System Configuration Menu – Open Channel Flow Applications (cont.)

The level System Configuration parameters on pages 16 & 17 need to be entered before the open channel flow configuration can be done. Enter these parameters prior to starting the open channel flow configuration shown below.

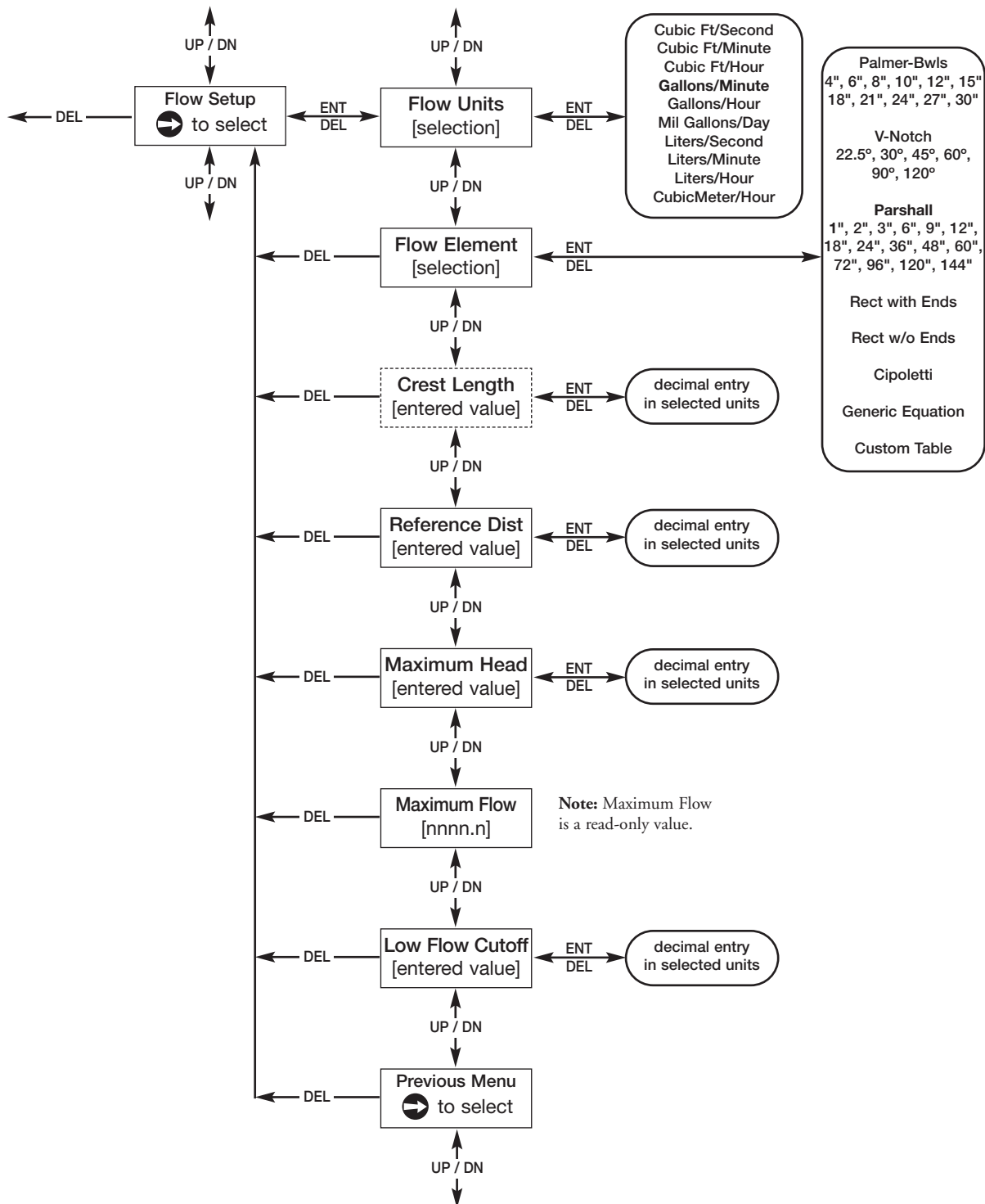

2.5.8.3 System Configuration Menu – Open Channel Flow Applications (cont.)

The following table provides an explanation of each of the System Configuration parameters for open channel flow applications using one of the Flow Elements that are stored in the firmware. See below and page 23 for dimensional information on the flumes and weirs.

Configuration Parameter	Explanation (Open Channel Flow Applications)
Flow Units	A selection of Gallons/Minute (factory default <i>Flow Unit</i>), Gallons/Hour , Mil Gallons/Day , Liters/Second , Liters/Minute , Liters/Hour , Cubic Meter/Hour , Cubic Ft/Second , Cubic Ft/Minute , and Cubic Ft/Hour are provided. Should some other units of flow be desired, the <i>Custom Unit</i> feature can be used in the Advanced Configuration Menu.
Flow Element	Select one of the following primary <i>Flow Elements</i> that are stored in the firmware: Parshall flume sizes of 1", 2", 3", 6", 9", 12", 18", 24", 36", 48", 60", 72", 96", 120" and 144" . Palmer-Bwls (Palmer-Bowlus) flume sizes of 4", 6", 8", 10", 12", 15", 18", 21", 24", 27" and 30" . V-notch weir sizes of 22.5°, 30°, 45°, 60°, 90° and 120° . Rect with Ends (Rectangular Weir with End Contractions), Rect w/o Ends (Rectangular Weir without End Contractions), and Cipoletti weir. Custom Table (see page 28) can be selected if none of the stored <i>Flow Elements</i> can be used. The table can be built with a maximum of 20 points. The 355 also has the capability of inputting a Generic Equation (see page 26) for flow calculation.
Crest Length	The <i>Crest Length</i> screen only appears when the chosen <i>Flow Element</i> is Cipoletti or one of the <i>Rectangular</i> weirs. Input this length in the user-selected level units.
Reference Dist	The <i>Reference Distance</i> is measured from the face of transducer to the point of zero flow in the weir or flume. This must be measured very accurately in the user-selected level units. For some <i>Flow Elements</i> , such as <i>Parshall</i> flumes, the <i>Reference Dist</i> is the same as the <i>Range</i> value. Weirs and some other <i>Flow Elements</i> will have a <i>Reference Distance</i> that is shorter than the <i>Range</i> value.
Maximum Head	<i>Maximum Head</i> is the highest liquid level (Head) value in the flume or weir before the flow equation is no longer valid. The <i>Maximum Head</i> is expressed in the user-selected <i>Level Units</i> . The 355 will default to the largest <i>Maximum Head</i> value that is allowed for any given flume or weir. The <i>Maximum Head</i> value can be revised depending on the value of the <i>Reference Distance</i> , or for end user preference.
Maximum Flow	<i>Maximum Flow</i> is a read-only value that represents the flow value corresponding to the <i>Maximum Head</i> value for the flume or weir.
Low Flow Cutoff	The <i>Low Flow Cutoff</i> (in user-selected level units) will force the calculated flow value to zero whenever the <i>Head</i> is below this point. This parameter will have a default and minimum value of zero.
Previous Menu	Previous Menu exits the flow Open Channel Flow Config menu.

2.5.8.3 System Configuration Menu – Open Channel Flow Applications (cont.)

The level System Configuration parameters on pages 16 & 17 need to be entered before the open channel flow configuration can be done. Enter these parameters prior to starting the open channel flow configuration shown below.

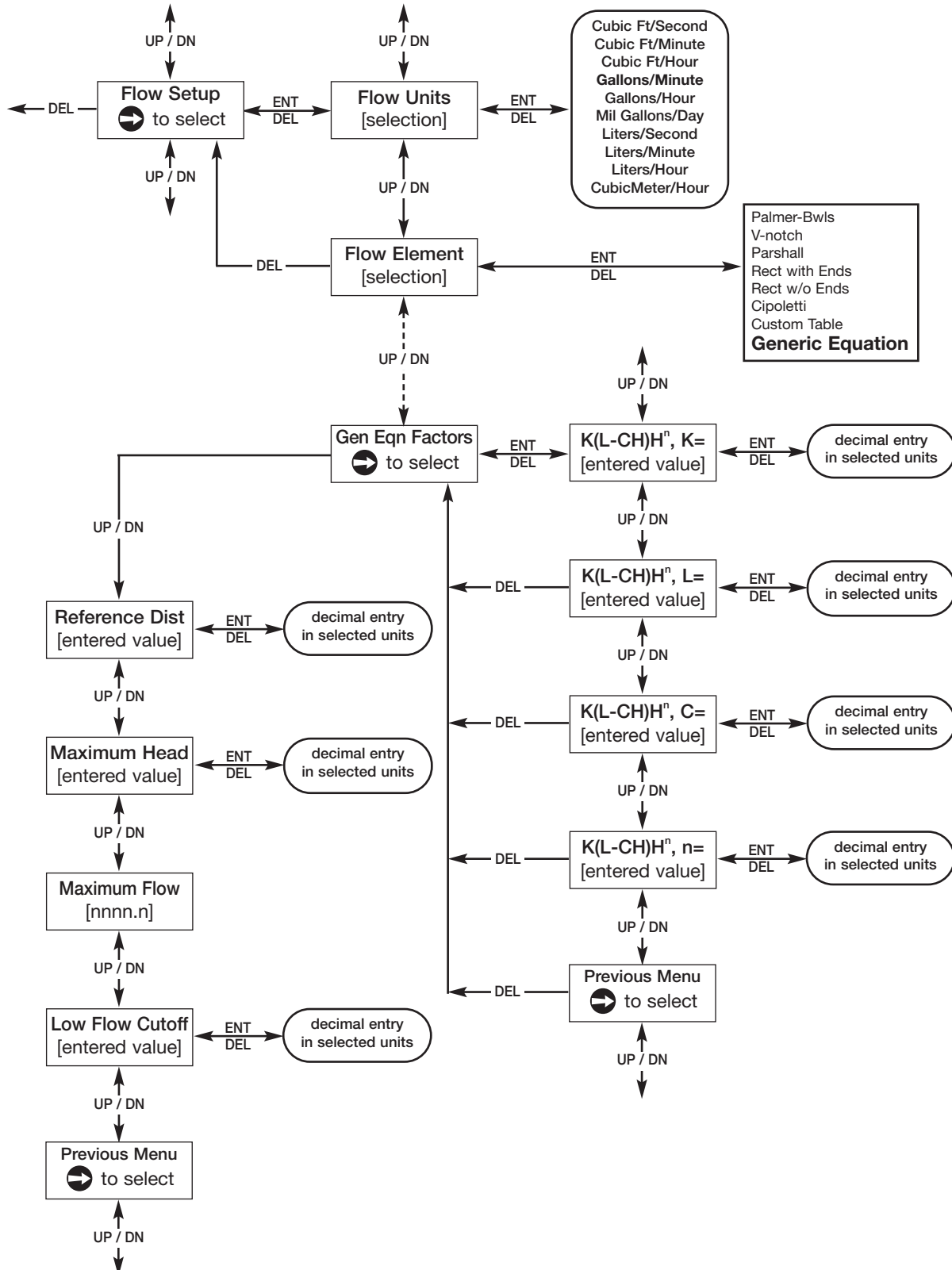

2.5.8.3 System Configuration Menu – Open Channel Flow Applications (cont.)

The following table provides an explanation of each of the System Configuration parameters for open channel flow applications using the Generic Equation.

Configuration Parameter	Explanation (Open Channel Flow Applications using the Generic Equation)
Flow Units	A selection of Gallons/Minute (factory default <i>Flow Unit</i>), Gallons/Hour, Mil Gallons/Day, Liters/Second, Liters/Minute, Liters/Hour, Cubic Meter/Hour, Cubic Ft/Second, Cubic Ft/Minute, and Cubic Ft/Hour are provided. Should some other units of flow be desired, the <i>Custom Unit</i> feature can be used in the Advanced Configuration Menu.
Flow Element	If none of the stored <i>Flow Elements</i> can be used, either a Custom Table can be built with a maximum of 20 points, or a Generic Equation can be entered that calculates the flow discharge rate.
Generic Eqn Factors	<i>Generic Equation</i> is a discharge flow equation in the form of $Q = K(L-CH)H^n$, where Q = flow (Cu Ft/Second), H = Head (Feet), K = a constant, and L, C and n are user input factors that depend on which <i>Flow Element</i> is being used. Make sure the flow equation is in the form of $Q = K(L-CH)H^n$, and proceed to enter the values of K,L,C,H and n. See example below.
Note: The Generic Equation parameters must be entered in Cu Ft/Second units . The resultant flow is converted by the 355 into whatever Flow Units are selected above. See example below.	
Reference Dist	The <i>Reference Distance</i> is measured from the face of the transducer to the point of zero flow in the weir or flume. This must be measured very accurately in the user-selected level units. For some <i>Flow Elements</i> , the <i>Reference Dist</i> is the same as the <i>Range</i> value. Weirs and some other <i>Flow Elements</i> , will have a <i>Reference Distance</i> that is shorter than the <i>Range</i> value.
Maximum Head	<i>Maximum Head</i> is the highest liquid level (Head) value in the flume or weir before the flow equation is no longer valid. The <i>Maximum Head</i> is expressed in the user-selected level units. The 355 will default to the largest <i>Maximum Head</i> value that is allowed for any given flume or weir. The <i>Maximum Head</i> value can be revised depending on the value of the <i>Reference Distance</i> , or for end user preference.
Maximum Flow	<i>Maximum Flow</i> is a read-only value that represents the flow value corresponding to the <i>Maximum Head</i> value for the flume or weir.
Low Flow Cutoff	The <i>Low Flow Cutoff</i> (in user-selected level units) will force the calculated flow value to zero whenever the <i>Head</i> is below this point. This parameter will have a default and minimum value of zero.
Previous Menu	Previous Menu exits the flow Open Channel Flow Config menu.

Generic Equation Example (using equation for an 8' rectangular weir w/ end contractions)		
Q = Cubic Ft/Second flow rate	L = 8' (weir crest length in feet)	H = Head value
K = 3.33 for Cubic Ft/Second units	C = 0.2 (constant)	n = 1.5 as an exponent

Using the factors above the equation becomes:

$$Q = 3.33 (8-0.2H) H^{1.5}$$

$$Q = K(L-CH)H^n$$

The discharge flow value for a Head value of 3 feet becomes 128.04 **Cubic Ft/Second**. If GPM was selected for the Flow Units, the 355 Measured Values screen would display this value converted to 57,490 GPM.

2.5.8.3 System Configuration Menu – Open Channel Flow Applications (cont.)

The level System Configuration parameters on pages 16 & 17 need to be entered before the open channel flow configuration can be done. Enter these parameters prior to starting the open channel flow configuration shown below.

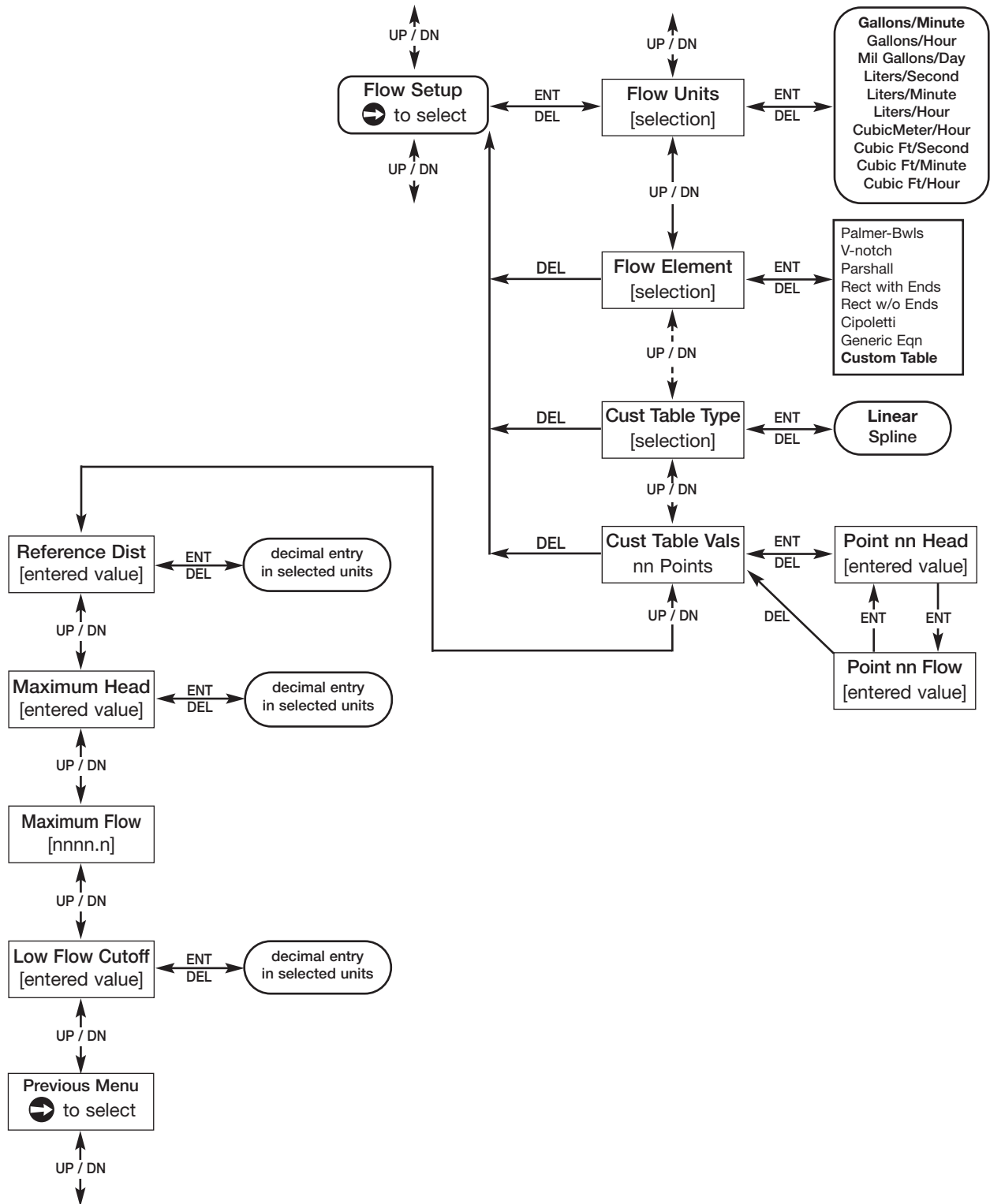

2.5.8.3 System Configuration Menu – Open Channel Flow Applications (cont.)

Concentrate points as follows:

- A. At least two points at beginning (P1 and P2);
- B. At least two points at end (P9 and P10);
- C. Three points at approximate average flow rate (for example, P3, P4, P5); and at transition point (P7) and points on either side (P6, P8).

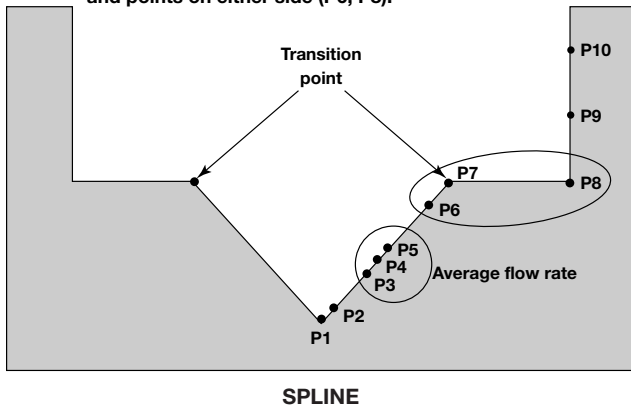

The following table provides an explanation of each of the System Configuration parameters for open channel flow applications using the Custom Table.

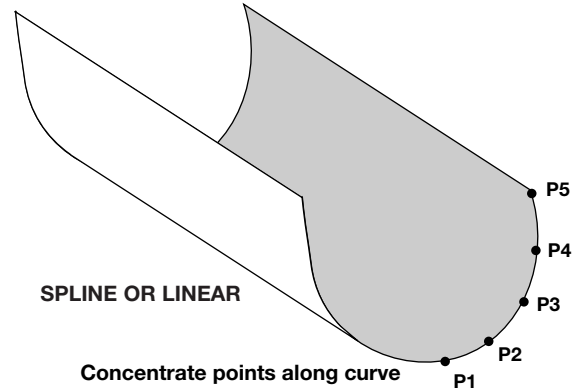

Configuration Parameter	Explanation (Open Channel Flow Applications using the Custom Table)
Flow Units	A selection of Gallons/Minute (factory default <i>Flow Unit</i>), Gallons/Hour, Mil Gallons/Day, Liters/Second, Liters/Minute, Liters/Hour, Cubic Meters/Hour, Cubic Ft/Second, Cubic Ft/Minute, and Cubic Ft/Hour are provided. Should some other units of flow be desired, the <i>Custom Unit</i> feature can be used in the Advanced Configuration Menu.
Flow Element	If none of the stored <i>Flow Elements</i> can be used, either a Custom Table can be built with a maximum of 20 points, or a Generic Equation can be entered that calculates the flow discharge rate.
Custom Table	The <i>Custom Table</i> points can be a Linear (straight line between adjacent points) or Spline (can be a curved line between points) relationship. See above drawing for more information.
Cust Table Vals	A maximum of 20 points can be used in building the <i>Custom Table</i> . Each pair of values will have a Head (height) in the units chosen in the <i>Level Units</i> screen, and the associated flow for that Head value. The values must be monotonic, i.e., each pair of values must be greater than the previous Head/flow pair. The last pair of values should have the highest Head value (usually the <i>Maximum Head</i> value) and the flow associated with that Head value.
Reference Dist	The <i>Reference Distance</i> is measured from the face of transducer to the point of zero flow in the weir or flume. This must be measured very accurately in the user-selected level units. For some <i>Flow Elements</i> , the <i>Reference Dist</i> is the same as the <i>Range</i> value. Weirs and some other <i>Flow Elements</i> , will have a <i>Reference Distance</i> that is shorter than the <i>Range</i> value.
Maximum Head	<i>Maximum Head</i> is the highest liquid level (Head) value in the flume or weir before the flow equation is no longer valid. The <i>Maximum Head</i> is expressed in the user-selected <i>Level Units</i> . The 355 will default to the largest <i>Maximum Head</i> value that is allowed for any given flume or weir. The <i>Maximum Head</i> value can be revised depending on the value of the <i>Reference Distance</i> , or for end user preference.
Maximum Flow	<i>Maximum Flow</i> is a read-only value that represents the flow value corresponding to the <i>Maximum Head</i> value for the flume or weir.
Low Flow Cutoff	The <i>Low Flow Cutoff</i> (in user-selected level units) will force the calculated flow value to zero whenever the <i>Head</i> is below this point. This parameter will have a default and minimum value of zero.
Previous Menu	Previous Menu exits the flow Open Channel Flow Config menu.

2.5.9 I/O Configuration Menu

The I/O Configuration Menu is used to set the 4-20 mA current loop values, the totalizer parameters, and the HART polling address. The totalizer screens only appear if the unit is being configured for open channel flow.

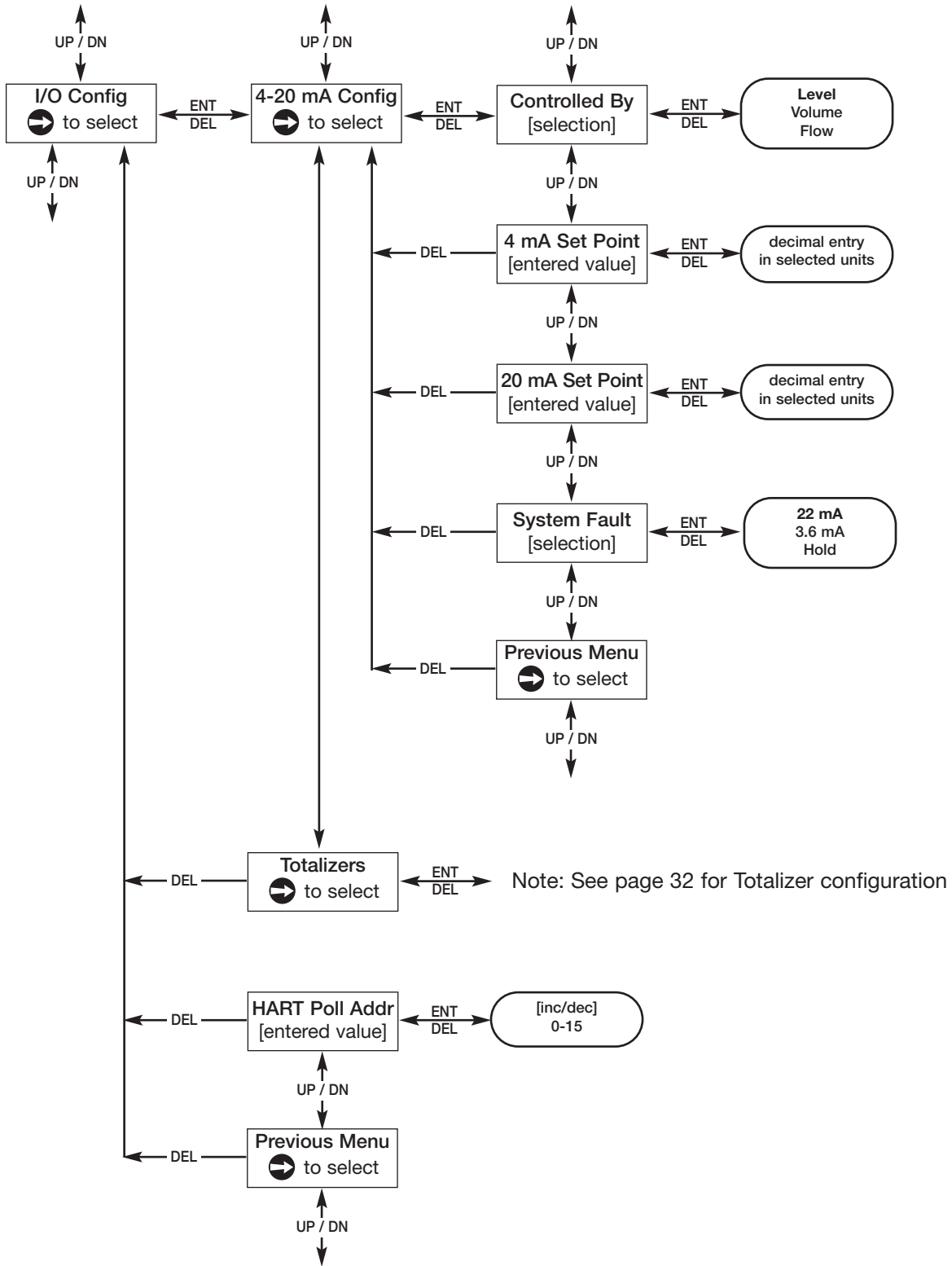

2.5.9 I/O Configuration Menu (cont.)

The opposite page shows the I/O Configuration Menu that is being used for configuring the 4-20 mA setpoints, and the HART polling address. If the 355 is being used for open channel flow, see pages 32 & 33 to configure totalizers.

Configuration Parameter	Explanation (4-20 mA Configuration)
Controlled By	The <i>Controlled By</i> screen sets which measurements (Level , Volume or Flow) will control the mA loop output, and also determines which will be the Primary Variable (PV). The <i>Controlled By</i> screen will not allow the existing value to be changed to a new value that is inconsistent with the chosen <i>Measure Type</i> (selected in the System Configuration Menu). It will revert to the original value in such cases.
4 mA Set Point	Enter the desired value for the <i>4 mA Set Point</i> in the measurement units selected above in the <i>Controlled By</i> screen. Note that during normal operation the mA value will never read into the <i>Level Offset</i> area that was configured on page 17.
20 mA Set Point	Enter the desired value for the 20 mA Set Point in the measurement units selected above in the <i>Controlled By</i> screen. Note that during normal operation the mA value will never read into the <i>Blocking Distance</i> area that was configured on page 17.
System Fault	Select 3.6 mA , 22 mA , or Hold (last value).
Previous Menu	Previous Menu exits the 4–20 mA Config menu.

Configuration Parameter	Explanation (Totalizers & HART Poll Address)
Totalizers	This screen will only appear if the 355 is being configured as an open channel flow transmitter. See pages 32 & 33 for the totalizer configuration screens.
HART Poll Addr	Select a <i>HART Poll Address</i> from 0–15. Enter 0 for a single transmitter installation. Enter 1–15 for a multi-drop network.
Previous Menu	Previous Menu exits the 4–20 mA Config menu.

2.5.9 I/O Configuration Menu (cont.)

The I/O Configuration Menu screens below are used to configure the totalizers when the 355 is being used for open channel flow.

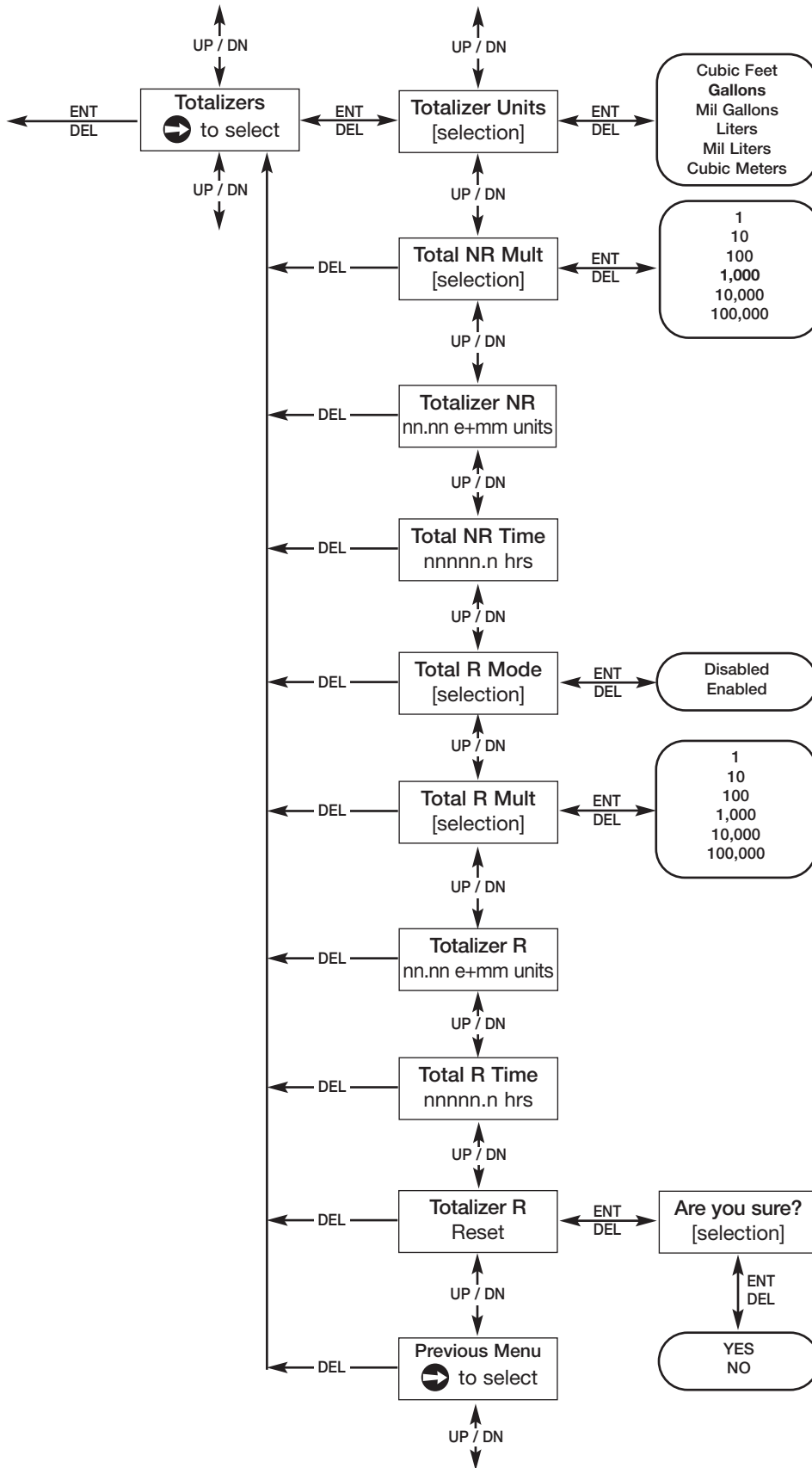

2.5.9 I/O Configuration Menu (cont.)

The I/O Configuration Menu screens below are used to configure the totalizers when the 355 is being used for open channel flow.

Configuration Parameter	Explanation (NR & R Totalizers)
Totalizer Units	The <i>Totalizer Units</i> screen is for selection of the units for both the resettable and non-resettable totalizers. Select Gallons (factory default unit) Mil Gallons , Liters , Mil Liters , Cubic Meters , or Cubic Feet .
Total NR Mult	The <i>Total NR Mult</i> screen allows selection of the multiplier to be used for the non-resettable totalizer. The function of the totalizer multiplier is such that if the chosen units are gallons and the multiplier is 100, the totalizer value will increment one whole unit for each 100 gallons. Select 1 , 10 , 100 , 1,000 (factory default multiplier), 10,000 or 100,000 .
Totalizer NR	This is a read only screen that displays the present value of the non-resettable totalizer.
Total NR Time	This is a read only screen that displays the time that has elapsed since the non-resettable totalizer has been totalizing flow.
Total R Mode	<i>Total R Mode</i> allows the user to enable and disable the resettable totalizer. The default mode is disabled.
Total R Mult	The <i>Total R Mult</i> screen allows selection of the multiplier to be used for the resettable totalizer. The function of the totalizer multiplier is such that if the chosen units are gallons and the multiplier is 100, the totalizer value will increment one whole unit for each 100 gallons. Select 1 , 10 , 100 , 1,000 (factory default multiplier), 10,000 or 100,000 .
Totalizer R	This is a read-only screen that displays the present value of the resettable totalizer.
Total R Time	This is a read-only screen that displays the time that has elapsed since the resettable totalizer has been totalizing flow.
Totalizer R Reset	The <i>Totalizer R Reset</i> screen allows the user to reset the total flow and elapsed time of <i>Totalizer R</i> to zero (<i>Totalizer NR</i> is non-resettable). Since this action will permanently lose this data, a second chance is provided with an "Are you sure?" screen.
Previous Menu	Previous Menu exits the Totalizer configuration.

2.5.10 Advanced Configuration Menu

The Advanced Configuration Menu contains items that most users will not need to configure for typical level, volume and flow applications. The figure below shows the first eight menu screens of the Advanced Configuration Menu. Page 36 shows the last eight menu screens, and page 38 shows the Echo Profile submenu.

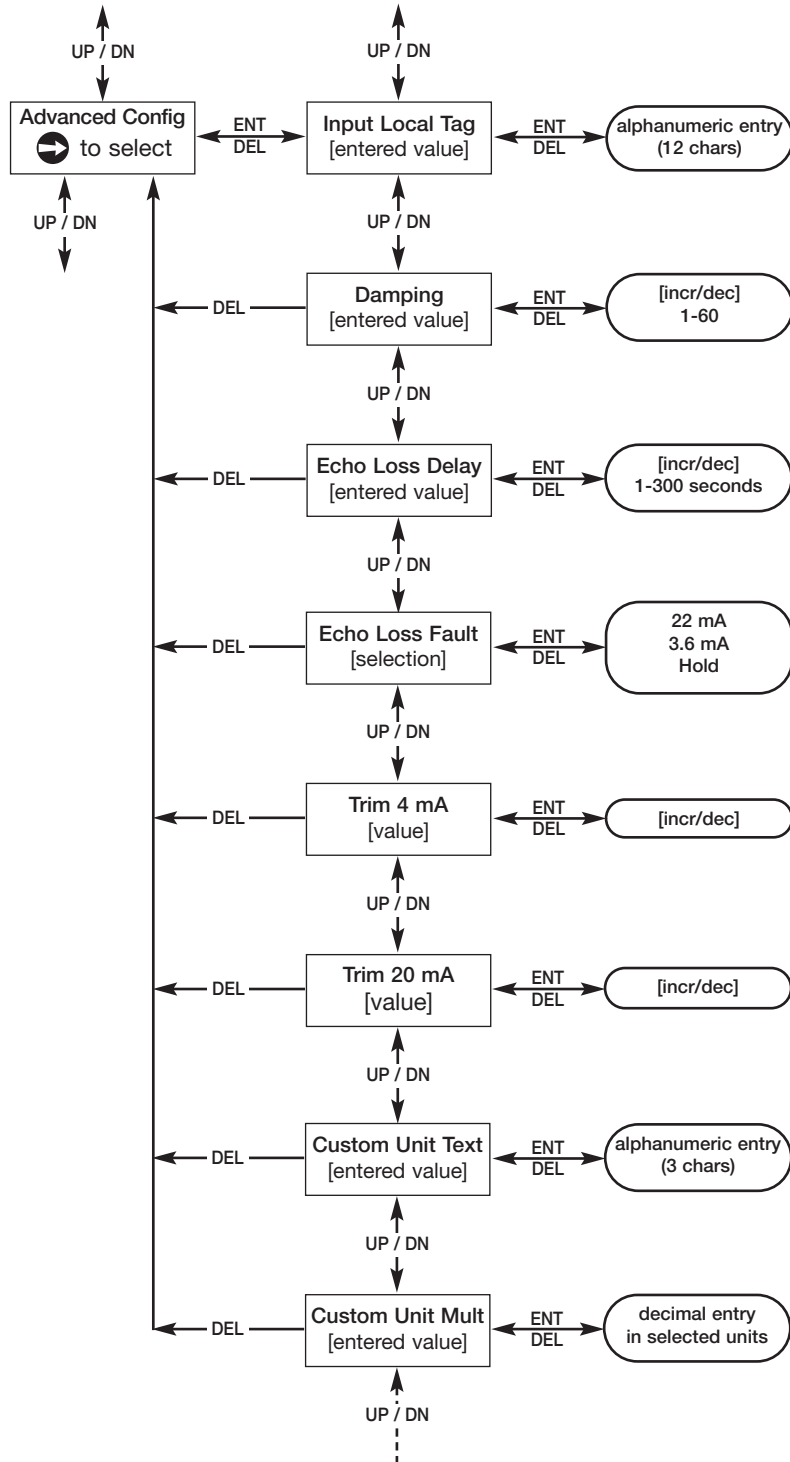

2.5.10 Advanced Configuration Menu (cont.)

The opposite page shows the first eight menu screens of the Advanced Configuration Menu. The following table provides an explanation of those parameters.

Configuration Parameter	Explanation
Input Local Tag	From the factory this tag is shown as “Model 355,” but this can be changed to describe the vessel tag number, loop number, or anything else. The tag can contain a maximum of 12 characters. All upper and lower case letters, numbers and 29 other characters are provided for the tag.
Damping	Increasing the <i>Damping</i> value will smooth the 355 display and/or the loop output if turbulence or other difficult application conditions are present. The default setting is 5, and this parameter can be set anywhere from 1–60.
Echo Loss Delay	Depending on the application, the 355 may temporarily lose the echo from the liquid surface. The <i>Echo Loss Delay</i> feature allows the transmitter additional time to reacquire the echo and keep a stable loop output. The default setting is 30 seconds, and this parameter can be set anywhere from 1–300 seconds.
Echo Loss Fault	This is the value the loop will go to after the 355 has lost the echo and the echo loss timer has expired. Select 22 mA (factory default value), 3.6 mA , or Hold (last value).
Trim 4 mA	This allows fine tuning of the 4 mA point. Since this is done at the factory, the user should not need to trim this value. If desired, attach a meter to the output and adjust the 5 digit value found in the <i>Trim 4 mA</i> screen until the meter reads 4.00 mA.
Trim 20 mA	This allows fine tuning of the 20 mA point. Since this is done at the factory, the user should not need to trim this value. If desired, attach a meter to the output and adjust the 5 digit value found in the <i>Trim 20 mA</i> screen until the meter reads 20.00 mA.
Custom Unit Text	The 355 has the capability to display a custom level, volume or flow unit if the user desires a unit that is not in the transmitter firmware. This could be millimeters, barrels, cubic meters/day, or any other unit. <i>Custom Unit Text</i> allows a 3-character abbreviation of the desired unit, which can be displayed along with the <i>Custom Unit</i> value on the Home Menu. See example below.
Custom Unit Mult	This multiplier is used to derive the <i>Custom Unit</i> value that can be shown on the Home Menu. The <i>Custom Unit</i> value is equal to the Primary Variable (selected via the <i>Controlled By</i> screen in I/O Config) times the <i>Custom Unit Mult</i> . See example below.

Custom Unit Example (millimeters)		
Controlled By (PV) = Level	Custom Unit Text = mm	Custom Unit Mult = 10.0
If Level = 460.8 cm	Custom Unit Value = 4608.00 mm	

NOTE: The resolution of the Model 355 is not improved by the use of custom units. Refer to Performance Specifications for expected resolution.

2.5.10 Advanced Configuration Menu (cont.)

The Advanced Configuration Menu contains items that most users will not need to configure for typical level, volume and flow applications. The figure below shows eight of the menu screens. The Echo Profile submenu screens are detailed starting on page 38.

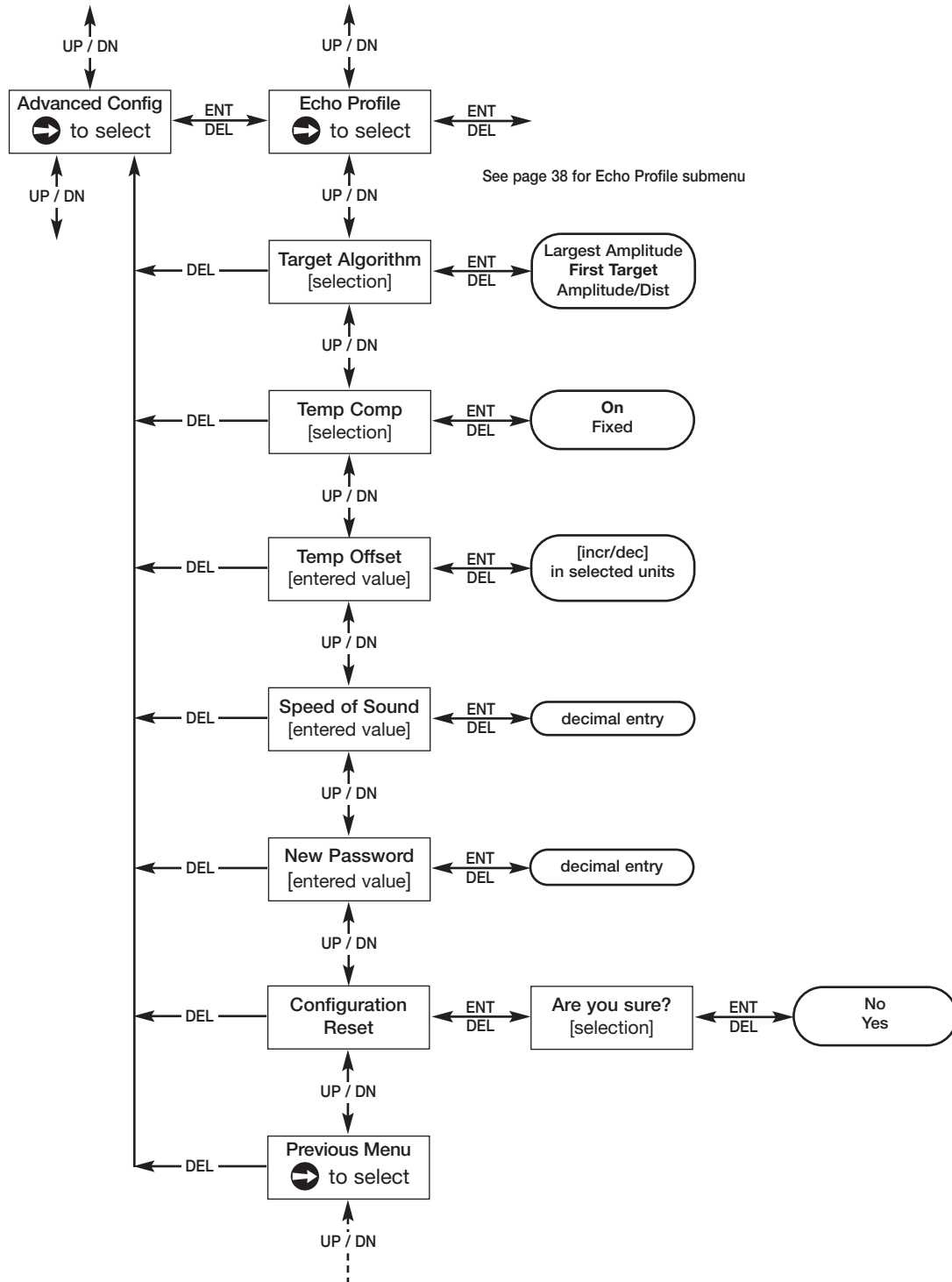

2.5.10 Advanced Configuration Menu (cont.)

The table below provides an explanation of the Advanced Configuration Menu screens from the opposite page.

Configuration Parameter	Explanation
Echo Profile	The <i>Echo Profile</i> submenu screens are shown on the next page.
Target Algorithm	The 355 has the capability of operating under three different <i>Target Algorithm</i> modes for acquiring the proper echo from the liquid surface. For almost all applications, the factory default of First Target is best for echo processing. Consult the factory for use of these algorithms.
Temp Comp	Since the speed of sound varies with temperature, the 355 provides temperature compensation for the air space between the transducer and the liquid surface. This <i>Temp Comp</i> feature should always be On . The Fixed mode should only be used if the temperature sensor has been damaged. Consult the factory for use of the Fixed mode.
Temp Offset	<i>Temp Offset</i> is used in conjunction with the <i>Temp Comp</i> feature. Consult the factory for use of this parameter.
Speed of Sound	The <i>Speed of Sound</i> through air is 331.45 meters/second at 0° C. Ultrasonic transmitters are generally not used in applications that have vapors other than air, since stratified layers of vapors develop that have different speed of sound propagation rates. Exceptions to this are tanks that have a homogenous gas (e.g., nitrogen) blanket. Consult the factory for use of this parameter.
New Password	The default password is 0, which effectively disables the password feature. This allows the configuration to be done without entering a password. If desired, a different password can be entered in the <i>New Password</i> screen. The password can be changed to any numerical value up to 255. If the password is changed from the factory default value of 0, then the new password will be required whenever any configuration values are changed.
NOTE: If the password is not known, the New Password screen displays an encrypted value representing the present password. Call the factory with this encrypted value to determine the actual password.	
Configuration Reset	The <i>Configuration Reset</i> screen can be used if it is determined that the configuration has been entered erroneously and it is desired to bring all configuration parameters back to their default values. Consult the factory for use of this parameter.
Previous Menu	Previous Menu exits the Advanced Config menu.

2.5.10 Advanced Configuration Menu (cont.)

The Advanced Configuration Menu contains items that most users will not need to configure for typical level, volume and flow applications. The figure below shows the screens for the Echo Profile submenu, should it be necessary to establish an echo rejection curve.

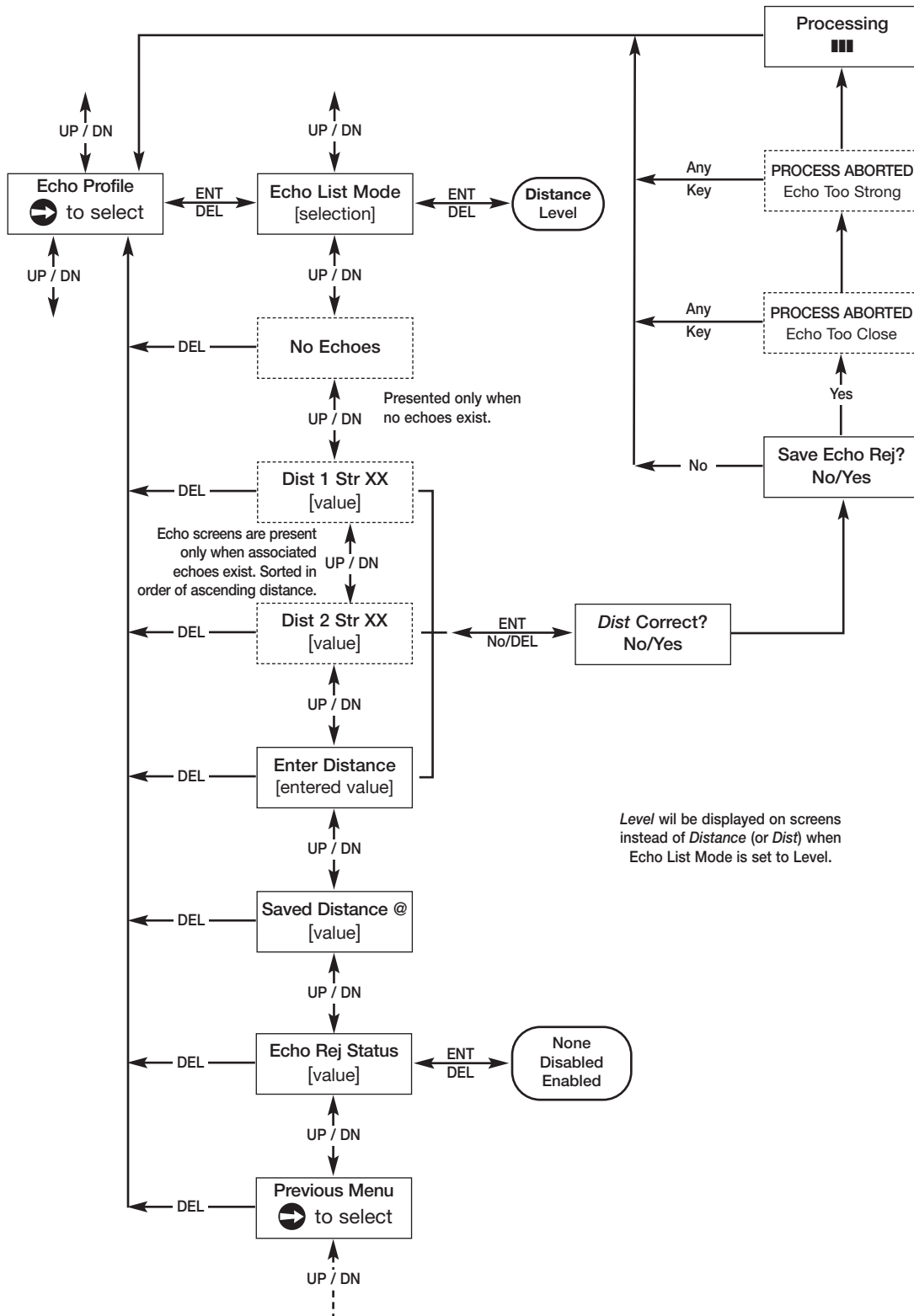

2.5.10 Advanced Configuration Menu (cont.)

The table below provides an explanation of the Echo Profile submenu screens shown on the opposite page. Two notes are worth pointing out:

1. If possible, the best answer to resolve issues deriving from false echoes in the tank is to reposition the 355 in a different mounting where the false echoes are eliminated or reduced.
2. This submenu can also be used to simply view a list of existing echoes (correct and/or false) for diagnostic purposes.

Configuration Parameter	Explanation (Echo Profile submenu)
Echo Profile	The <i>Echo Profile</i> submenu contains parameters that can be used to manage the false target rejection functionality of the transmitter.
Echo List Mode	The <i>Echo List Mode</i> screen allows a selection of Distance (factory default) or Level . This specifies whether the echoes presented in this submenu are in relation to their Distance from the face of the transducer, or in terms of Level in the tank.
No Echoes	The <i>No Echoes</i> screen is only displayed when the 355 cannot detect any echoes at all.
Note: The example below shows typical screens that might be presented if the <i>Echo List Mode</i> is Distance and the <i>Level Units</i> are inches .	
Dist 1 23.9 in Str 45	If echoes are detected (correct and/or false) from one to nine echoes will be presented. The correct echo is usually the one that shows the highest Strength (Str) value. In the example on the left, the first echo may be an obstruction in the ultrasonic beam, the second echo is the correct one, and the third may be a secondary echo coming from the liquid surface.
Dist 2 75.3 in Str 70	
Dist 3 151.8 in Str 22	
Enter Distance	If the correct echo is not listed, and it is still desired to create a new Echo Rejection Curve, the exact liquid distance or level can be entered in the <i>Enter Distance (or Enter Level)</i> screen.
Note: If no echoes are shown, it is advised to check the mounting location and to review the application, as opposed to manually entering the distance or level in this screen.	
Dist Correct?	If desired, a new Echo Rejection Curve can be established by pressing ENTER on the echo screen that represents the current liquid distance or level. Upon pressing ENTER the <i>Dist Correct?</i> Screen will be presented. A selection of Yes or No is offered to make sure that the echo is the correct one.
Save Echo Rej?	If Yes was selected in the <i>Dist Correct?</i> screen, then the <i>Save Echo Rej?</i> screen appears. This screen allows one more chance to abort creating a new Echo Rejection Curve, if it has not been confirmed that the selected echo is the correct echo from the liquid surface.
(Table continues on next page.)	

2.5.10 Advanced Configuration Menu (cont.)

Configuration Parameter	Explanation (Echo Profile submenu)
Processing ■ ■ ■ ■ ■ ■ ■ ■	<p>If No is selected in <i>Save Echo Rej?</i>, the process is aborted and the transmitter returns to the main <i>Echo Profile</i> submenu screen. If Yes is selected, and no errors are detected, a “progress-bar” <i>Processing</i> screen is shown while the transmitter processes, stores, and enables the new Echo Rejection Curve. It is not possible to leave this screen until the <i>Processing</i> has been completed (this may take 30 seconds or longer). Once complete, the 355 returns to the main <i>Echo Profile</i> submenu screen. If an error occurs, “PROCESS ABORTED” will be displayed on the upper line along with “Echo Too Close” or “Echo Too Strong” on the lower line. This may indicate that the vessel is too full to process an Echo Rejection Curve. Another Echo Rejection curve should be attempted after the level is reduced in the vessel.</p>
Saved Distance @	<p>The <i>Saved Distance/Level @</i> screen displays the distance (or level) at which the existing Echo Rejection Curve was created. This screen is only presented when a valid Echo Rejection Curve exists.</p>
Echo Rej Status	<p>The <i>Echo Rej Status</i> screen displays the current status (None, Disabled, or Enabled) of the Echo Rejection Curve. The factory default value of None indicates that an Echo Rejection Curve does not exist or was invalidated. Pressing ENTER when the <i>Echo Rej Status</i> is None has no effect since it cannot be Enabled or Disabled. If an Echo Rejection Curve has been created, then it can be Disabled or Enabled by pressing ENTER. Selecting Disabled will disengage an existing Echo Rejection Curve without affecting the stored profile. Once Disabled it is possible to view false echoes and decide if it is necessary to run a new Echo Rejection Curve.</p>
Previous Menu	<p>Previous Menu exits the Echo Profile submenu.</p>

2.5.11 Diagnostics Menu

The Diagnostics Menu contains both informational items and diagnostic screens that can assist in troubleshooting the 355 if faults or warnings occur.

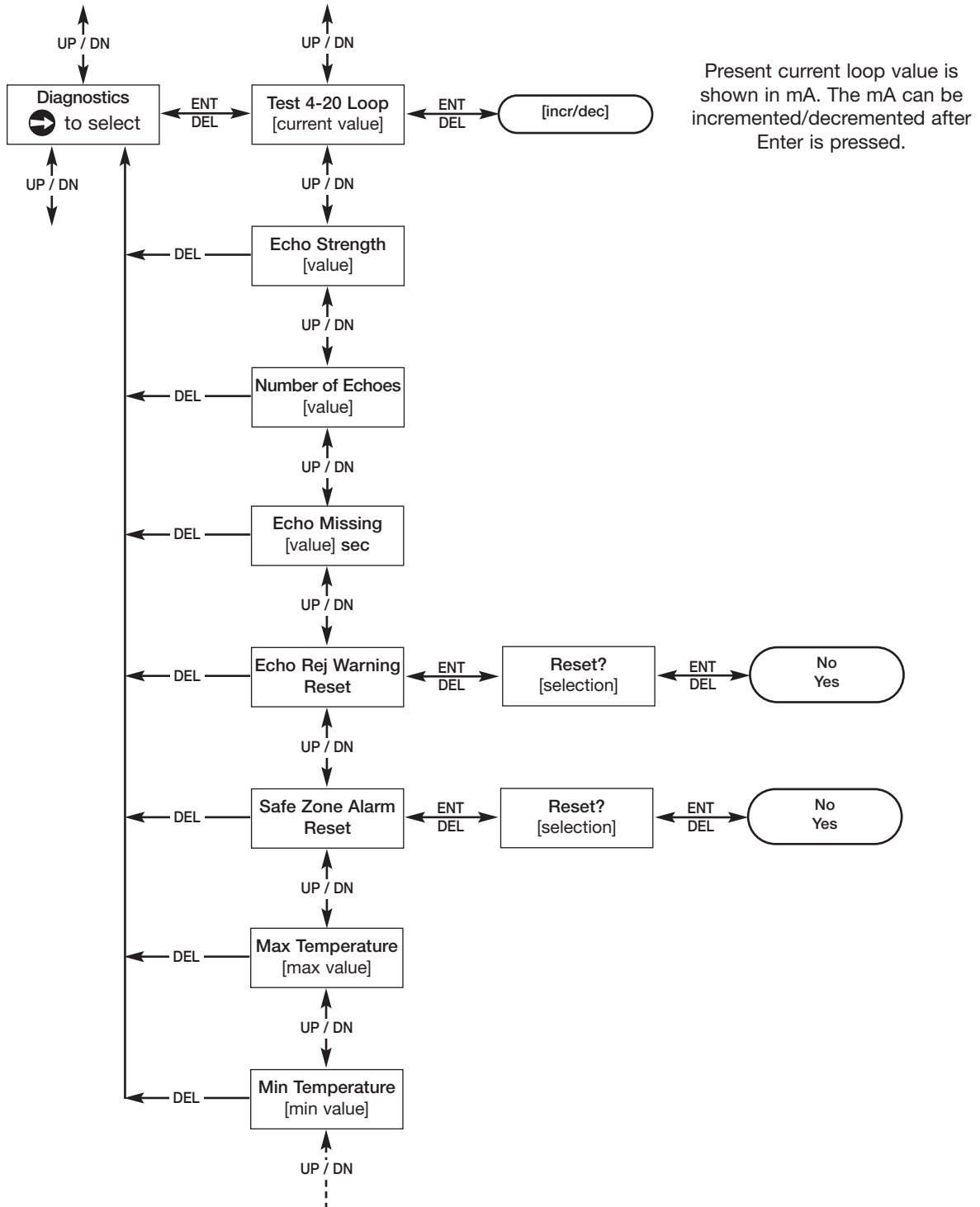

2.5.11 Diagnostics Menu (cont.)

The table below provides an explanation of the first eight items in the Diagnostics Menu. The remaining screens of the Diagnostic Menu are shown on the next page.

Configuration Parameter	Explanation
Test 4-20 Loop	This screen allows any value from 3.6 to 22.0 mA to be entered to test the loop output.
Echo Strength	This parameter is an indication of the relative strength of the echo identified as the correct echo coming from the target or liquid surface. The <i>Echo Strength</i> value varies from 0 (echo loss) to 100.
Number of Echos	The 355 can process as many as 9 echos at a time and still keep track of the correct echo from the liquid surface. This parameter shows the <i>Number of Echos</i> the transmitter is detecting.
Echo Missing	The 355 can lose the echo for as long as the <i>Echo Loss Delay</i> period that is set in Advanced Configuration prior to going into the <i>Echo Loss Fault</i> condition. The <i>Echo Missing</i> screen shows how many seconds have passed since the echo has been lost.
Echo Rej Warning Reset	A warning message will be displayed on the Home Menu screen if a non-volatile memory exception has corrupted the Echo Rejection Curve, or if this curve has been invalidated. The curve can become invalidated if one of the key configuration parameters was changed after the curve was set up. This <i>Echo Rej Warning Reset</i> screen allows a reset of this warning message, so that it can be removed from the Home Menu. A new Echo Rejection Curve should be run and saved.
Safe Zone Alarm Reset	If liquid level enters the <i>Safe Zone Height</i> (see System Configuration) and the <i>Safe Zone Fault</i> has been set to either 3.6 mA , 22 mA , Latch 3.6 mA or Latch 22 mA then "SafeZoneAlrm" will be displayed on the LCD. Once liquid level has dropped below Safe Zone Height, the alarm will clear unless the Latch feature has been selected. The <i>Safe Zone Alarm Reset</i> screen allows this latching to be reset after the liquid level has fallen out of the <i>Safe Zone Height</i> area.
Max Temperature	This parameter displays the maximum transducer temperature ever recorded.
Min Temperature	This parameter displays the minimum transducer temperature ever recorded.

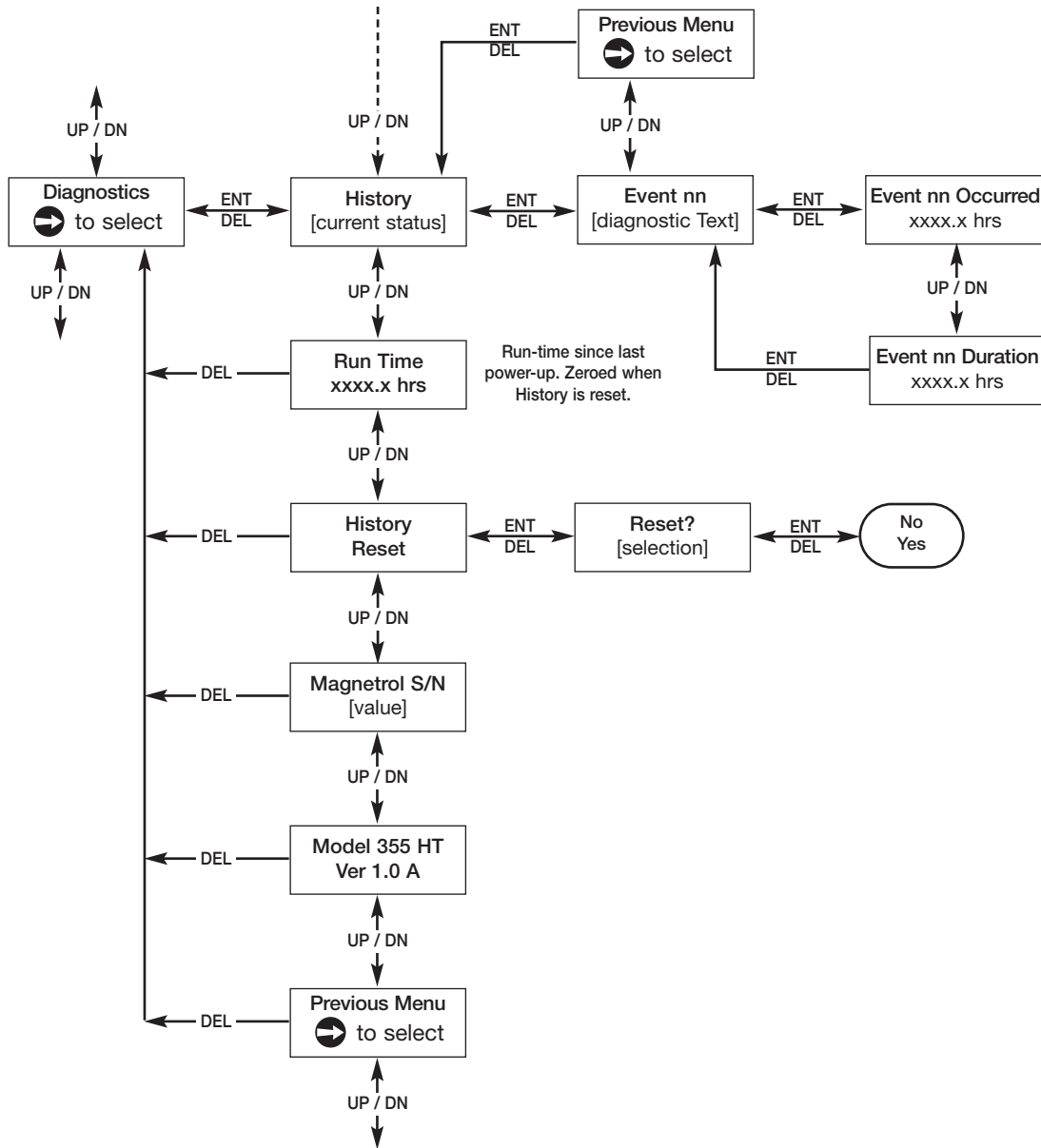

2.5.11 Diagnostics Menu (cont.)

The Diagnostics Menu contains both informational items and diagnostic screens that can assist in troubleshooting the 355 if faults or warnings occur.



2.5.11 Diagnostics Menu (cont.)

The table below provides an explanation of the remaining screens of the Diagnostic Menu.

Configuration Parameter	Explanation
History	The <i>History</i> screen displays the present status and the sequence in which any diagnostic events may have occurred. The 2nd line of the menu shows the present status. If there are no present diagnostic events, this screen will have <i>History</i> on the top line and OK on the bottom line. Pressing  descends to a lower menu level to view diagnostic events that have been logged in <i>History</i> . Each “Event” is indicated by the event number label. The first event number label presented corresponds to the most recent diagnostic event. This event number also indicates the number of diagnostic events currently in the <i>History</i> submenu. Up to 10 events can be stored in the <i>History</i> submenu. It is also possible to display the relative time of occurrence and the duration of each event. This is done with a third menu level displayed by pressing  again.
Run Time	The <i>Run Time</i> screen shows how much time has elapsed since the 355 transmitter has been powered up.
History Reset	The <i>History Reset</i> screen provides a means to clear all of the diagnostics events that are stored in the <i>History</i> log.
Magnetrol S/N	This read-only screen displays the serial number of the unit.
Model 355 HT Ver 1.0a	If the “HT” is shown on the top line of this read only screen, the 355 has HART digital communications capability. If “NP” (No Protocol) is shown on the top line, then the transmitter does not have HART. The bottom line displays the firmware version.
Previous Menu	Previous Menu exits the Diagnostic Menu.

2.5.12 Factory Configuration Menu

The Factory Configuration Menu contains items that cannot be configured without assistance from the factory. Contact the factory if any of these parameters need to be modified.

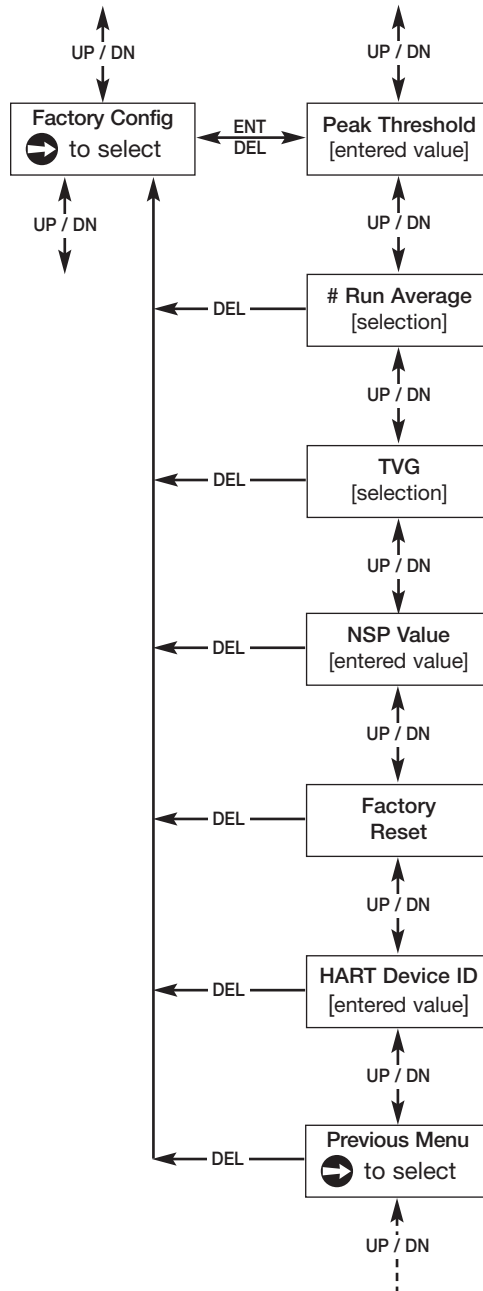

2.6 Configuration Using HART®

A HART® (Highway Addressable Remote Transducer) remote unit, such as a HART communicator, can be used to provide a communication link to the Model 355 transmitter.

When connected to the control loop, the same system measurement readings that are shown on the transmitter are shown on the communicator. The communicator can also be used to configure the transmitter.

To confirm HART handheld communications, attach the unit as shown in the figure on the left. If the communicator reads GENERIC on the first two lines, then the HART handheld does not contain the current DDs (Device Descriptions) for the 355 transmitter. Contact your local HART Service Center and specify a Magnetrol Echotel Model 355 Device Description.

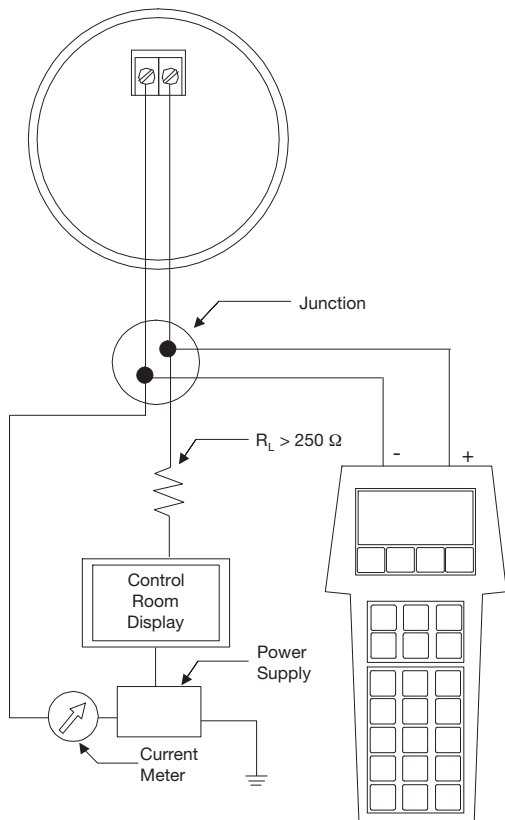

HART Revision Table

HART Version	HCF Release Date	Compatible with 355 Software
Dev V1 DD V2	September 2008	Version 1.0a and later

2.6.1 Connections

A HART communicator can be operated from a remote location by connecting it to a remote junction or by connecting it directly to the terminal block in the electronics housing of the 355 transmitter.

HART uses the Bell 202 frequency shift key technique of high-frequency digital signals. It operates on the 4–20 mA loop and requires 250 Ω load resistance. A typical connection between a communicator and the 355 transmitter is shown at the left.

2.6.2 Display Menu

A typical communicator display is an 8-line by 21-character LCD. When connected, the top line of each menu displays the model (Model 355) and its tag number or address. Usually the bottom line of each menu is reserved for software defined function keys (F1–F4). For detailed operating information, refer to the instruction manual provided with the HART communicator.

The 355 transmitter online menu trees are shown in the following pages. Open the menu by pressing the alphanumeric key 1, Device Setup, to display the second level menu.

3.1.1 Troubleshooting System Problems

Symptom	Problem	Solution
Level reading locked onto a value that is not correct level	Measurement engine finding a reflection it believes is the correct level signal	Run an Echo Rejection Curve with the Level below this point (or with empty tank) to eliminate false echoes
LEVEL, % Output and LOOP values are all inaccurate	Basic configuration data may be questionable	<ol style="list-style-type: none"> 1. Check validity of all configuration data 2. Check DISTANCE value of device against manually measured distance
LEVEL readings are repeatable but consistently high (or low) from actual by a fixed amount	Configuration data does not accurately match tank dimensions	<ol style="list-style-type: none"> 1. Ensure proper values for Range 2. Check vessel for present liquid level. Trim Level can be used to ensure exact measurement 3. Reconfigure LOOP values if necessary
LEVEL reading on Display is correct but LOOP is stuck at 4 mA	HART Poll Address set a value of 1-15	Set HART Poll Address to 0
LEVEL reading on Display stuck at value related to Blocking Distance	The 355 believes the transducer is flooded (level very near or on transducer)	Check actual level. If transducer is not flooded, power down, then power-up transmitter with the level well below the transducer. Increase the Blocking Distance.

3.1.2 Error Messages

The Echotel 355 transmitter utilizes a 3-level hierarchy for reporting diagnostic conditions: FAULTS, WARNINGS, and INFORMATION. Faults and Warnings can be reviewed in the rotating screens in the Home menu. These screens capture only current conditions. Historical diagnostic information can be viewed at the HISTORY screen in the Diagnostic Menu.

FAULT: The highest level in the hierarchy of diagnostics. A Fault annunciates a defect or failure in the circuitry or software that makes reliable measurement impossible. The current (mA) value unit defaults to 3.6, 22, or HOLD and a message is displayed on the rotating screen. Further error information can be obtained by reviewing the Diagnostic Menu screens.

WARNING (MESSAGE): This is the second level in the hierarchy of diagnostics. A Warning annunciates conditions that are not fatal but may affect measurement. A message will occur on the Home (rotating) screen when a Warning is detected but will not affect output current. Further error information can be obtained by reviewing the Diagnostic Menu screens.

INFORMATION (MESSAGE): This is the lowest level in the hierarchy of diagnostics. Information messages are for conditions that provide operational factors that are not critical to measurement. Further error information can be obtained by reviewing the Diagnostic Menu screens.

3.1.2 Error Messages

Diagnostic	Fault Description	LCD Message
Non-Volatile Memory Exceptions	a) System Config parameters defaulted b) Advanced Config parameters defaulted c) I/O Config parameters defaulted d) Factory Config parameters defaulted e) HART parameters defaulted f) Strapping Table parameters defaulted g) Totalizer parameters defaulted	DfltParm Sys DfltParm Adv Dflt Parm I/O DfltParmFact DfltParmHART DfltCustmTbl DfltParm Tot
I/O Configuration	Measurement Type and Loop Controlled By selections are incompatible (e.g., Flow selected for control but is not being calculated).	CnfgConflict
Hardware Failure	The "HardwareFail" fault will be indicated if there is a hardware failure. Contact the factory for assistance.	HardwareFail
Loop Failure	The actual current generated in the 4–20 mA loop differs significantly (>1 mA) from the intended loop current.	Loop Failure
Temperature Sensor Failure	A short or open in the connection to the temperature sensor.	Temp Failure
Block Dist	Elevated signals are impinging on the Blocking Distance point. This may or may not be caused by excessive ringing of the transducer.	Block Dist
High Volume/Flow Alarm	The measured level exceeds the highest level in the strapping table by more than 5%, or the applicable range of the equations / data sets involved.	HiVolumeAlrm Hi Flow Alrm
Safe Zone Alarm	The level has risen to within the configured Safe Zone region in the tank.	SafeZoneAlrm
Echo Lost	No valid echo from the liquid surface has been received for a period exceeding the Echo Loss Delay.	Echo Lost

Diagnostic	Warning Description	LCD Message
Low Loop Voltage	The transmitter's minimum voltage requirement may not be met when the loop is driven to 22.0 mA.	LowVDC@20mA
Noise	Spurious signals similar in magnitude to echoes are detected.	Noise
Temp Limits Exceeded	The transducer temperature exceeds +80°C or –40°C.	High Temp Low Temp
Corrupt Echo Rejection Partition	Non-Volatile Memory exception for Echo Rejection partition.	EchoRej Crpt
Invalid Echo Rejection Curve	A stored Echo Rejection Curve has been invalidated (usually because a key configuration parameter was changed).	EchoRej Invl
Initial Startup	Displayed during "warm-up" period.	Initializing

Diagnostic	Diagnostic Information Description	LCD Message
Echo Strength	A numerical indication of the relative strength of the echo identified as the liquid surface.	Echo Strength xx
Number of Echos	The number of echoes detected.	Number of Echos
Echo Missing	The duration (in seconds) that echoes have been missing.	Echo Missing xx sec
Temperature Extrema	Maximum and minimum measured temperatures will be stored in non-volatile memory, resettable only by the factory.	Min Temp xxx °F/C Max Temp xxx °F/C
Echo Profile	A means to display the attributes of all the echos detected in the receive signal.	Refer to Advanced Config Menu

3.2 Measurement Range Calculations

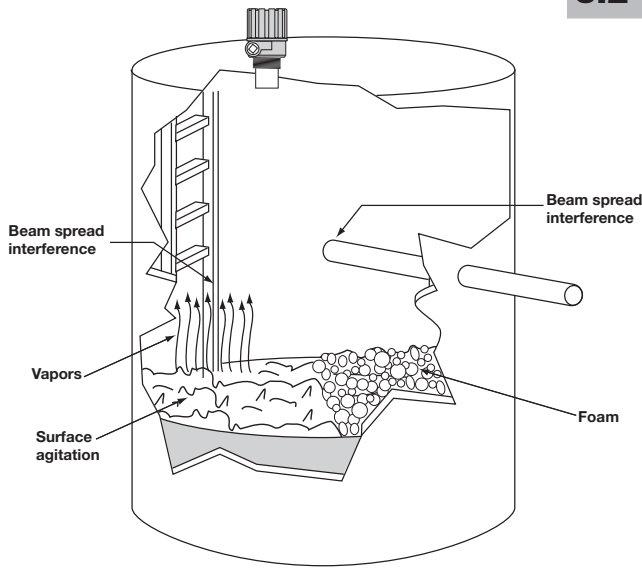

Ultrasonic non-contact transmitters are typically rated for a maximum range in ideal conditions. Experience has shown that maximum range must be reduced for certain factors. Although the maximum range rating is somewhat conservative, each application must be evaluated for specific conditions in the tank.

Several application parameters that affect ultrasonic performance are shown in the tank at the left. Each of these parameters is assigned a Performance Multiplier in the chart below. Multiply the maximum potential range (20 feet or 6 meters) of the Model 355 by each of the applicable Performance Multipliers to calculate the maximum allowable range for the application.

Operating parameter	Condition	Performance Multiplier
SURFACE AGITATION: Surface agitation or waves can degrade the performance. Moderate agitation results in only slight degradation of performance. The worst case is when the surface is a good reflector, but in the wrong direction.	Smooth, glass-like surface	1.0
	Slight agitation, choppiness	0.9
	Heavy agitation	0.8
	Slight vortex	0.7
VAPORS AND STEAM: Vapors can cause problems when the liquid process temperature is well above the temperature of the airspace. The greater the difference, the more expected vapor problems. The problems result from condensation or layering in the sound path, both of which attenuate the sound signal, and degrade performance. If a vent is used, be sure that it is well away from the transducer.	No condensation	1.0
	Little condensation	0.9
	Much condensation / foggy appearance	0.8
BEAM SPREAD INTERFERENCE: It is recommended that no obstructions, such as ladder rungs, fill pipes, support struts, etc., be allowed within the 10° ultrasonic beam. If an obstruction is unavoidable, make it as far away as possible from the transducer. Interference from agitator blades is only an intermittent interference that usually has little effect on performance. A special software algorithm can also help suppress false echoes from agitator blades that are within the beam angle.	No interference within 5° half beam angle	1.0
	Agitator at speed less than 60 RPM	1.0
	Agitator at speed greater than 60 RPM	C/F
	Interference outside 2°, far from transducer (in bottom third of range)	0.8
	Interference outside 2°, near to transducer (in top third of range)	0.5
FOAM: Foam can attenuate the ultrasound and render the system inoperative. If possible, moving the transducer to an area in the tank where there is less foam will improve the performance. Thick, heavy-density foams can sometimes produce a reflection from the top of the foam.	No foam	1.0
	Light froth, less than 0.25" thick	0.8
	Light foam, less than 0.5" thick	0.5
	Light foam, more than 1" thick	0.1

EXAMPLE: A slightly agitated 12-foot tank with no condensation, no interference, and a light froth on the surface.

Maximum allowable range: $20' \times 0.9 \times 1.0 \times 1.0 \times 0.8 = 14.4$ feet
 Since the maximum allowable range is 14.4 feet, the 355 is suitable for this 12-foot tank.

NOTE: The multipliers shown above are general guidelines.
 For further assistance consult the factory.

3.3 Speed of Sound Through Gases

The speed of sound through air is 331.45 meters/sec (1,087 feet/sec) at 0° C (+32° F) as indicated in Section 2.5.10. This speed is the basis for all measurements made by the Model 355 transmitter. The table below contains the speed of sound for various gases measured @ +32° F (0° C). These values can be used to alter the speed of sound value in Section 2.5.10. This should only be done if the gas exists as a homogeneous layer (such as a nitrogen blanket) in the tank.

Gases	Chemical Formula	Velocity (m/s)
Argon	Ar	307
Carbon monoxide	CO	337
Methane	CH ₄	433
Methanol	CH ₃ OH	335
Neon	Ne	435
Nitrogen	N ₂	334
Nitrous oxide	N ₂ O	263
Oxygen	O ₂	316
Propane	C ₃ H ₈	235

3.4 Parts

3.4.1 Replacement Parts

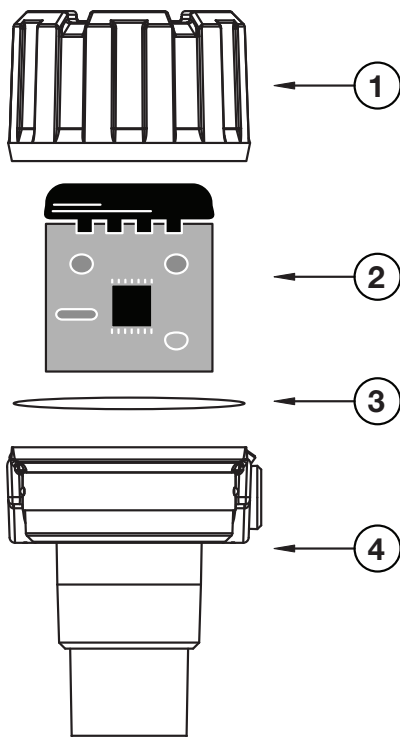

Replacement Cover, Electronics Module and O-Ring		
Item	Description	Part Number
1	Cast aluminum housing cover	036-4410-010
1	Lexan housing cover	003-1226-003
2	Electronic module without HART for aluminum housing	089-9125-001
2	Electronic module without HART for Lexan housing	089-9125-002
2	Electronic module with HART for aluminum housing	089-9125-003
2	Electronic module with HART for Lexan housing	089-9125-004
3	Cast aluminum housing O-ring	012-2201-237
3	Lexan housing O-ring	012-2616-001

Transducer Replacement Kit with Cast Aluminum Housing Base		
Item	Description	Part Number
4	FM I.S. & N.I. approvals, 3/4" NPT conduits, Polypropylene transducer	089-9126-001
4	FM I.S. & N.I. approvals, 3/4" NPT conduits, Kynar Flex® transducer	089-9126-002
4	FM I.S. & N.I. approvals, M20 conduits, Polypropylene transducer	089-9126-003
4	FM I.S. & N.I. approvals, M20 conduits, Kynar Flex transducer	089-9126-004
4	ATEX I.S. approvals, 3/4" NPT conduits, Polypropylene transducer	089-9126-007
4	ATEX I.S. approvals, 3/4" NPT conduits, Kynar Flex transducer	089-9126-008
4	ATEX I.S. approvals, M20 conduits, Polypropylene transducer	089-9126-009
4	ATEX I.S. approvals, M20 conduits, Kynar Flex transducer	089-9126-010
4	ATEX XP approvals, 3/4" NPT conduits, Polypropylene transducer	089-9126-011
4	ATEX XP approvals, M20 conduits, Kynar Flex transducer	089-9126-012



3.4.1 Replacement Parts (cont.)

Transducer Replacement Kit with Lexan (Plastic) Housing Base		
Item	Description	Part Number
4	FM I.S. & N.I. approvals, 3/4" NPT conduits, polypropylene transducer	089-9126-013
4	FM I.S. & N.I. approvals, 3/4" NPT conduits, Kynar Flex transducer	089-9126-014
4	FM I.S. & N.I. approvals, M20 conduits, polypropylene transducer	089-9126-015
4	FM I.S. & N.I. approvals, M20 conduits, Kynar Flex transducer	089-9126-016
4	ATEX I.S. approvals, 3/4" NPT conduits, Polypropylene transducer	089-9126-017
4	ATEX I.S. approvals, 3/4" NPT conduits, Kynar Flex transducer	089-9126-018
4	ATEX I.S. approvals, M20 conduits, Polypropylene transducer	089-9126-019
4	ATEX I.S. approvals, M20 conduits, Kynar Flex transducer	089-9126-020

3.4.2 Recommended Spare Parts

Description	Part Number
Electronic module per Section 3.4.1	089-9125-00X
Transducer replacement kit per Section 3.4.1	089-9126-0XX

3.5 Agency Approvals

AGENCY	MODEL	PROTECTION METHOD	AREA CLASSIFICATION
FM 	355-5X0A-11R 355-5X0A-10R	Intrinsically Safe	Class I, Div. 1; Groups A, B, C, & D Type 4X, IP66, T4 @80°C ^② Entity
	355-5X0A-1XX	Intrinsically Safe	Class I, Div. 1; Groups A, B, C, & D IP67, T4 @80°C ^② Entity
	355-5X0A-1XX	Non-Incendive ^①	Class I, Div. 2; Groups A, B, C, & D IP67, T4 @80°C ^②
ATEX 	355-5X0A-AXX	Intrinsically Safe	ATEX II 1 G Ex ia IIC T4 @70°C ISSeP09ATEX013X (EN 60079-0, EN 60079-11 & EN 60079-26 standards applied)
	355-5X0A-C0R 355-5X0A-C1R	Explosion Proof	ATEX II 1/2 G Ex ma/d IIC T6 @70°C Ga/Gb ISSeP09ATEX009X ^③ (EN 60079-0, EN 60079-1, EN 60079-18 & EN 60079-26 standards applied)

① Measured media inside vessel must be non-flammable only.

② Process temperature must not increase the internal temperature of the electronics above 176° F (80° C).

③ Refer to Section 2.3 for special Conditions for Safe Use



These units have been tested to EN 61326 and are in compliance with the EMC Directive 2004/108/EC.

3.5.1 Agency (FM/FMc) Drawing and Entity Parameters

REVISIONS			
SYM	DESCRIPTION	BY & DATE	CHANGE NO.
B	SEE SHEET ONE, FOR REVISIONS	RC03-03-09	5188-575

HAZARDOUS LOCATIONS
 Model 355, ECHOTEL ULTRASONIC THRU-AIR TRANSMITTER
 Intrinsically Safe for CL I, Div. 1 Groups A,B,C,D

ENTITY
 $V_{max} = 28.6V$
 $I_{max} = 140mA$
 $P_{max} = 1.0W$
 $C_i = 5.5nF$
 $L_i = 9.4uH$

NON HAZARDOUS LOCATIONS
 Limiting Values

$V_{oc} \leq 28.6V$ $C_a \geq 5.5nF$
 $I_{sc} \leq 140mA$ $L_a \geq 9.4uH$

The voltage (V_{max}) and current (I_{max}), which the transmitter can receive, must be equal to or greater than the maximum open circuit voltage (V_{oc}) and the maximum short circuit current (I_{sc}) which can be delivered by the source device. In addition, the maximum capacitance (C_i) and inductance (L_i) of the load and the capacitance and inductance of the interconnecting wiring must be equal to or less than the capacitance (C_a) or the inductance (L_a), which can be driven by the source device.

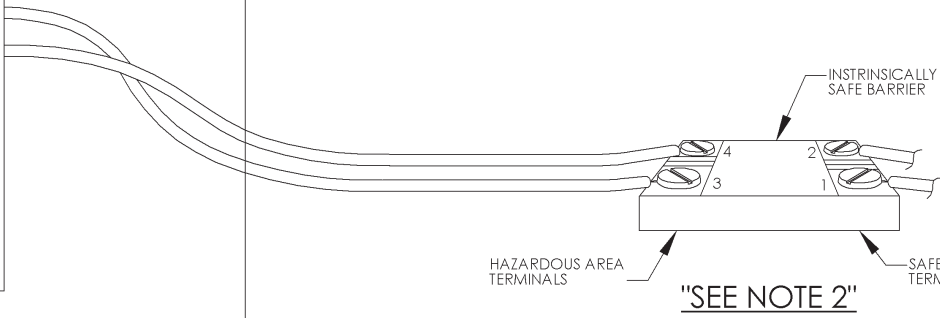
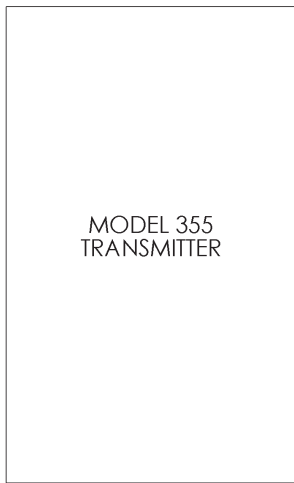

NOTES:

1. Manufacturers installation instructions supplied with the protective barrier and the CEC (for Canada) or the NEC and ANSI/ISA RP 12.6 (For US) must be followed when installing the equipment. The Associated Apparatus must be FM Approved.
2. Control equipment connected to protective barriers must not use or generate more than 250 Vdc or V_{rms} . Resistance between Intrinsically Safe ground and earth ground must be less than 1.0 Ohm.
3. No revisions to this drawing without FM approval.
4. For Canada: Exia Intrinsically Safe / Securitie Intrinseque
5. **Warning - Explosion Hazard** – Substitution of components may impair Intrinsic Safety.
Warning - Explosion Hazard – Do not disconnect equipment unless power has been switch off or the area is known to be non-hazardous.
6. For supply connections, use wire suitable for operating temperature. For 80°C ambient, use wire with a minimum temperature rating of 85°C
7. The device can also be installed in Class I, Div. 2 Groups A B C D; Hazardous Locations and does not require connection to a protective barrier when installed per the CEC (for Canada) or the NEC (for US) and when connected to a power source not exceeding 30V. Field wiring must be installed in conduit per the CEC and the NEC.
8. The FM Approved Associated Apparatus must be a linear output device.

AGENCY LISTED DRAWING
 ALL REVISIONS TO THIS DRAWING REQUIRE QA APPROVAL

5300 BELMONT ROAD, DOWNER'S GROVE ILLINOIS 60515, AREA CODE 630/969-4000
099-5067 SHEET 2 OF 2

3.6 Specifications

3.6.1 Transmitter

Supply Voltage	XP & GP	16 to 36 VDC
	IS	16 to 28.6 VDC
IS Entity Parameters	FM/FMc	V _{max} = 28.6 V, I _{max} = 140 mA P _{max} = 1.0 W, C _i = 5.5 nF, L _i = 9.4 μH
	ATEX	U _i = 28.4 V, I _i = 94 mA, P _i = 0.67 W C _i = 5.5 nF, L _i = 370 μH
Power Consumption		Less than 1 Watt
Output:	Type	4–20 mA with optional HART digital signal
	Range	3.8 to 20.5 mA useable
	Diagnostic Alarm	Selectable from 3.6 mA, 22 mA or HOLD
	Damping	Adjustable from 1–60
Digital Communication		HART version 5.x compatible
Display		2-line x 16-character LCD
Keypad		4-pushbutton menu-driven
Ambient Temperature		-40° to +175° F (-40° to +80° C)
Housing Material		Cast aluminum or Lexan
Cable Entry		Two 3/4" NPT or M20 entries

3.6.2 Transducer

Maximum Range	20 feet (6 meters)
Minimum Range	13 inches (330 mm)
Blocking Distance	10 inches (250 mm)
Frequency	60 kHz
Process Connection	2" NPT
Process Temperature	-40° to +175° F (-40° to +80° C)
Process Pressure	0 to 43.5 psig (0 to 3 bar)
Material	Kynar Flex (PVDF) or polypropylene
Beam Angle	10° conical

3.6.3 Performance ^①

Accuracy	Greater of ± 0.2% of range or 0.24 inch (6 mm)
Repeatability	± 0.125 inch (± 3 mm)
Resolution	0.1 inch (2.5 mm)
Linearity	± 0.4 inch (±10 mm)
Response Time	Less than 1 second (typical)
Warm-up Time	30 seconds

^① Performance is based on a reference operating condition of an ambient temperature of +60° to +77° F (+15° to +25° C), 45 to 75% relative humidity, transducer vertically aligned over an ideal reflecting surface, and no false targets within the ultrasonic beam angle.

3.6.4 Physical

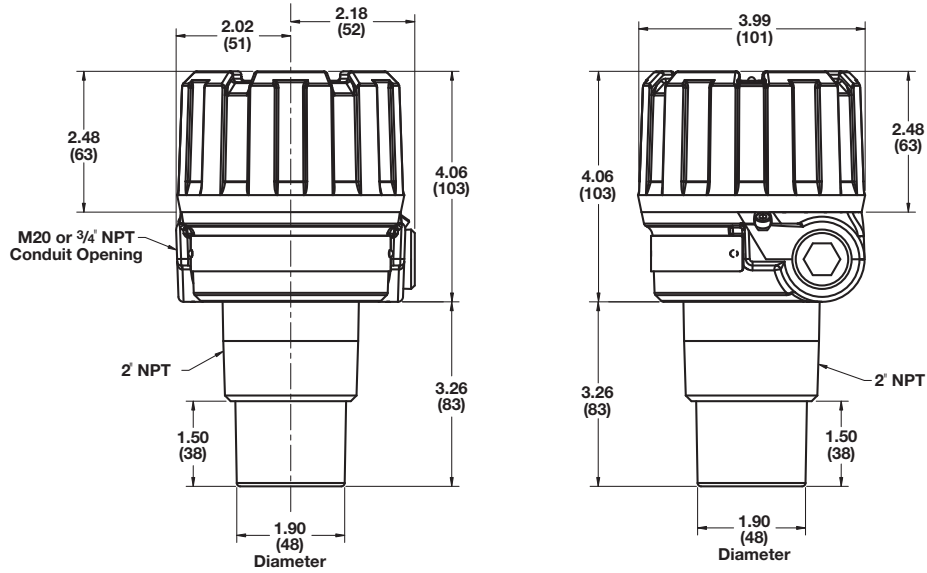

**Cast Aluminum Housing with
Kynar®/Polypropylene Transducer**

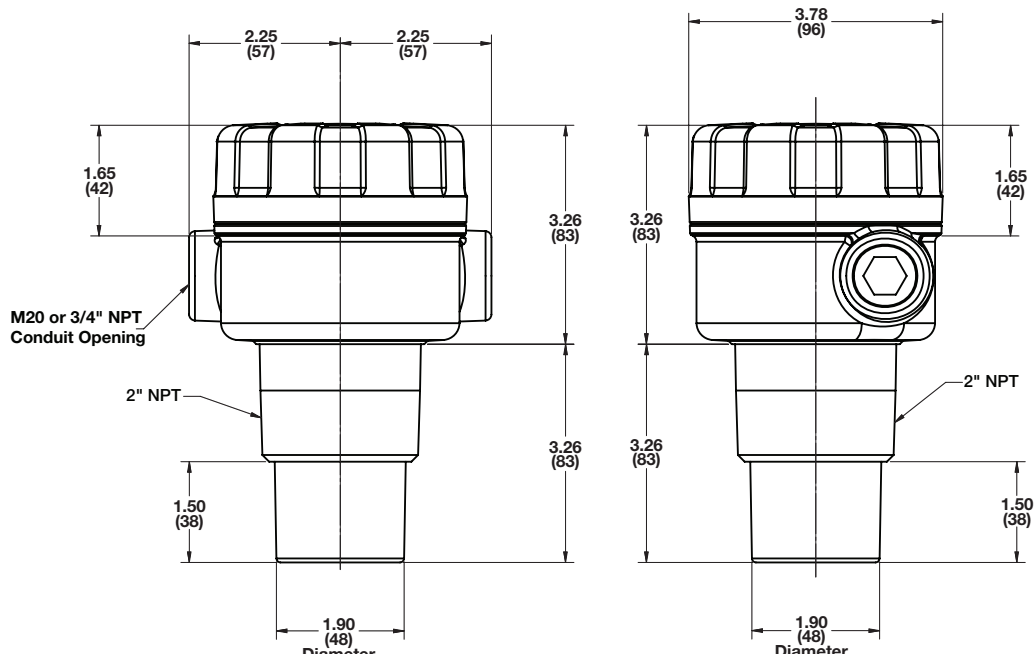

**Lexan® Housing with
Kynar®/Polypropylene Transducer**

3.7 Model Number



BASIC MODEL NUMBER

355	Ultrasonic transmitter for level, volume and open channel flow
-----	--

POWER

5	24 VDC two-wire loop-powered
---	------------------------------

SIGNAL OUTPUT

0	4-20 mA without HART®
1	4-20 mA with HART

OPTIONS

0	None
---	------

ACCESSORIES

A	Digital display and keypad
---	----------------------------

AGENCY APPROVALS

1	FM/FMc IS & Non-incendive
A	ATEX IS EEx ia
C	ATEX XP EEx d (only available with Housing codes 0 & 1, and Transducer code R)

HOUSING/CONDUIT CONNECTION

0	Cast aluminum w/ 3/4" NPT conduit connections
1	Cast aluminum w/ M20 conduit connections
6	Lexan plastic w/ 3/4" NPT conduit connections
7	Lexan plastic w/ M20 conduit connections

TRANSDUCER

B	2" NPT polypropylene
R	2" NPT Kynar® Flex

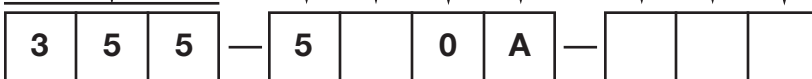



Echotel Model 355 Transmitter

Configuration Data Sheet

-SYSTEM CONFIGURATION		
	Default Value	Present Value
Measure Type	Level Only	
Level Units	Inches	
Range	240.0"	
Blocking Dist	10"	
Safe Zone Fault	None	
Safe Zone Height	2"	
Level Offset	0.0"	
Trim Level	0.0"	
Flow Setup		
	Default Value	Present Value
Flow Units	Gallons/Minute	
Flow Element	Parshall 1"	
Reference Dist	120.0"	
Low Flow Cutoff	0.0"	

DIAGNOSTICS MENU		
	Default Value	Present Value
Echo Strength		
Number of Echoes		
Max/Min Temperature		
Run Time		
Magnetrol S/N		
Model 355 Version		

I/O CONFIGURATION		
	Default Value	Present Value
Controlled By	Level	
4 mA Set Point	0.0"	
20 mA Set Point	230.0"	
System Fault	22 mA	
Totalizer Units	Gallons	
Total NR Mult	1000	
Total R Mode	Disabled	
Total R Mult	1000	

ADVANCED CONFIGURATION		
	Default Value	Present Value
Input Local Tag	Model 355	
Damping	5	
Echo Profile	See table below for Echo Profile	
Target Algorithm	First Target	

FACTORY CONFIGURATION		
	Default Value	Present Value
Peak Threshold	18	
# Run Average	8	
TVG	2	
HART Device ID		

MEASURED VALUES

	Value	Value
Level		
Volume		
Flow		
Head		
Distance		
% Output		

	Value	Value
Loop Current		
Local Tag		
Temperature		
Totalizer R		
Totalizer NR		
Custom Units		

HISTORY (IN DIAGNOSTIC MENU)		
Event # and Event	Occurred	Duration
1		
2		
3		
4		
5		
6		
7		
8		
9		
10		

ECHO LIST (ECHO PROFILE IN ADVANCED CONFIG)		
Dist/Level Echo #	Strength Value	Dist/Level Value
1		
2		
3		
4		
5		
6		
7		
8		
9		

Service Policy

Owners of Magnetrol/STI controls may request the return of a or any part of a control for complete rebuilding or replacement. They will be rebuilt or replaced promptly. Controls returned under our service policy must be returned by prepaid transportation. Magnetrol/STI will repair or replace the control at no cost to the purchaser (or owner) other than transportation if:

1. Returned within the warranty period; and
2. The factory inspection finds the cause of the claim to be covered under the warranty.

If the trouble is the result of conditions beyond our control; or, is NOT covered by the warranty, there will be charges for labor and the parts required to rebuild or replace the equipment.

In some cases it may be expedient to ship replacement parts; or, in extreme cases a complete new control, to replace the original equipment before it is returned. If this is desired, notify the factory of both the model and serial numbers of the control to be replaced. In such cases, credit for the materials returned will be determined on the basis of the applicability of our warranty.

No claims for misapplication, labor, direct or consequential damage will be allowed.

Return Material Procedure

So that we may efficiently process any materials that are returned, it is essential that a "Return Material Authorization" (RMA) number be obtained from the factory, prior to the material's return. This is available through Magnetrol's or STI's local representative or by contacting the factory. Please supply the following information:

1. Company Name
2. Description of Material
3. Serial Number
4. Reason for Return
5. Application

Any unit that was used in a process must be properly cleaned in accordance with OSHA standards, before it is returned to the factory.

A Material Safety Data Sheet (MSDS) must accompany material that was used in any media.

All shipments returned to the factory must be by prepaid transportation.

All replacements will be shipped F.O.B. factory.



5300 Belmont Road • Downers Grove, Illinois 60515-4499 • 630-969-4000 • Fax 630-969-9489 • www.magnetrol.com
145 Jardin Drive, Units 1 & 2 • Concord, Ontario Canada L4K 1X7 • 905-738-9600 • Fax 905-738-1306
Heikensstraat 6 • B 9240 Zele, Belgium • 052 45.11.11 • Fax 052 45.09.93
Regent Business Ctr., Jubilee Rd. • Burgess Hill, Sussex RH15 9TL U.K. • 01444-871313 • Fax 01444-871317



5300 Belmont Road • Downers Grove, Illinois 60515-4499 • 630-969-4028 • Fax 630-969-9489 • www.sticontrols.com

Copyright © 2009 Magnetrol International, Incorporated. All rights reserved. Printed in the USA.

HART is a registered trademark of the HART Communication Foundation
Kynar is a registered trademark of Pennsalt Chemicals Corp.
Lexan is a registered trademark of General Electric

BULLETIN: 51-661.0
EFFECTIVE: May 2009